

SPECIFICATION

REFOND P/N

RF-A3H10-W63P-E4

R&D

Mass Production

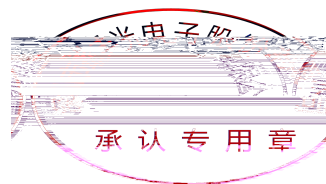

Contents

1. Description	3
1.1 General Description	3
1.2 Features	3
1.3 Application	3
1.4 Package Dimension	3
1.5 Product Parameters	5
1.5 Bin Range Of Forward Voltage and Total Radiant Flux	5
BIN	5
1.6 Typical optical characteristics curves	7
2. Packaging	10
2.1 Packaging Specification	12
2.1.1 Carrier Tape Dimension	12
2.1.2 Reel Dimension	12
2.1.3 Label Form Specification	13
2.2 Moisture Resistant Packing	13
2.3 Cardboard Box	13
2.4 Reliability Test Items And Conditions	14
2.5 Criteria For Judging Damage	15
3. SMT Reflow Soldering Instructions SMT	16
3.1 SMT Reflow Soldering Instructions SMT	16
4. Handling Precautions	18

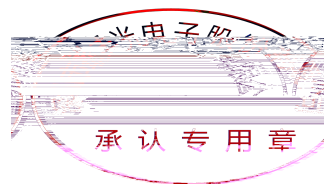

1. Description

1.1

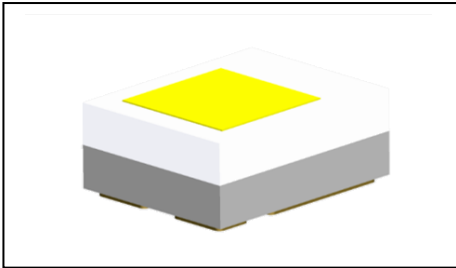

This product uses the ceramics package, it has a high reliability. it also be widely application for Automotive Exterior Lighting. Size(mm): 2.00X1.60X0.80mm.

2.00X1.60X0.80mm

1.2 Features

Ceramic Package.

High Power Output and High Luminance.

Pb-free reflow soldering application.

Moisture sensitive level:Level2.

Level 2

RoHS compliant. RoHS

1.3 Application

Automotive Exterior Lighting, Daytime Running Lamp, Headlamp, Fog lamp.

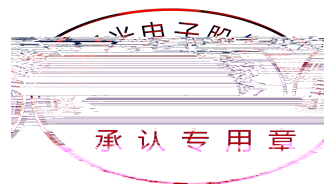

1.5 Product Parameters

Table 1-1 Electrical / Optical Characteristics at Ts=25°C

Table 1-2 Absolute Maximum Ratings at Ts=25°C

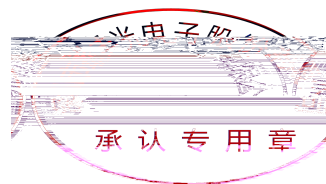

Notes

1. 1/10 Duty cycle, 0.1ms pulse width. 0.1ms, 1/10.
2. The above forward voltage measurement allowance tolerance is $\pm 0.1V$. $\pm 0.1V$.
3. The above color coordinates measurement allowance tolerance is ± 0.005 . ± 0.005 .
4. The above luminous flux measurement allowance tolerance $\pm 10\%$. $\pm 10\%$.
5. Care is to be taken that power dissipation does not exceed the absolute maximum rating of the product.
6. All measurements were made under the standardized environment of Refond.
7. When the LEDs are in operation the maximum current should be decided after measuring the package temperature, junction temperature should not exceed the maximum rate. LED

1.6 Bin Range Of Forward Voltage and Luminous Flux (IF=1000mA)

BIN (IF=1000mA)

Table 1-3

V_F V	G0	H0	I0	J0	/	/
	2.8-3.0	3.0-3.2	3.2-3.4	3.4-3.6	/	/
(lm)	WC	WD	WE	WF	/	/
	260-280	280-300	300-320	320-340	/	/

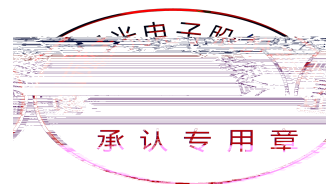

The Chromaticity Diagram



Bin data

BIN CODE	X1	Y1	X2	Y2	X3	Y3	X4	Y4
63N	0.3043	0.3295	0.3091	0.3069	0.3251	0.3218	0.3233	0.3468

1.7 Typical optical characteristics curves

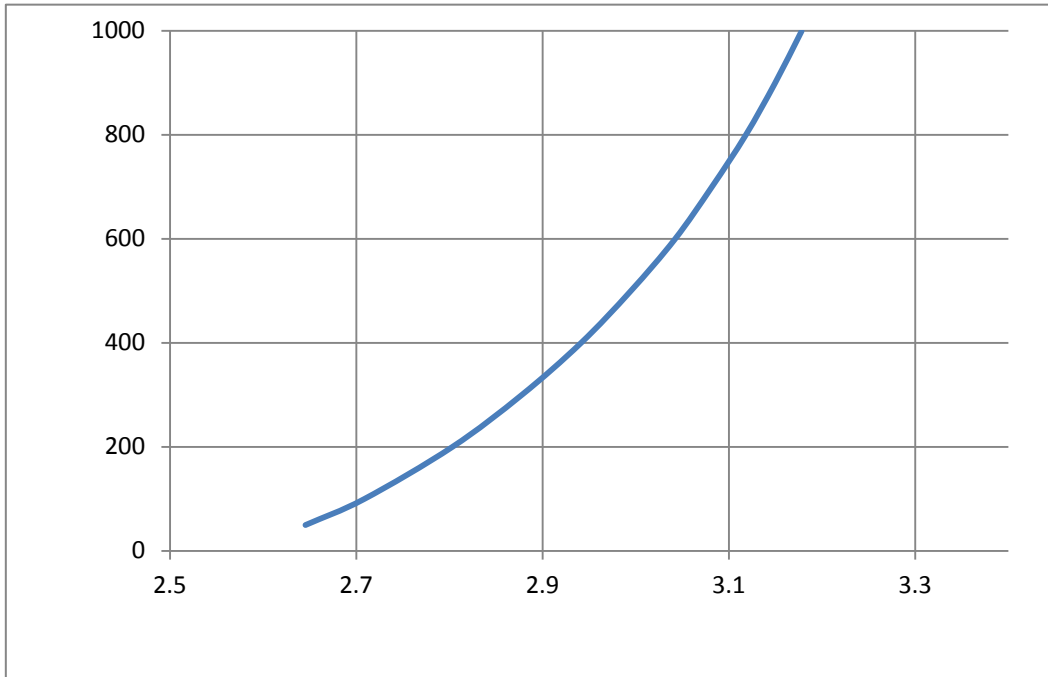

Fig 1-6 Forward Voltage Vs. Forward Current

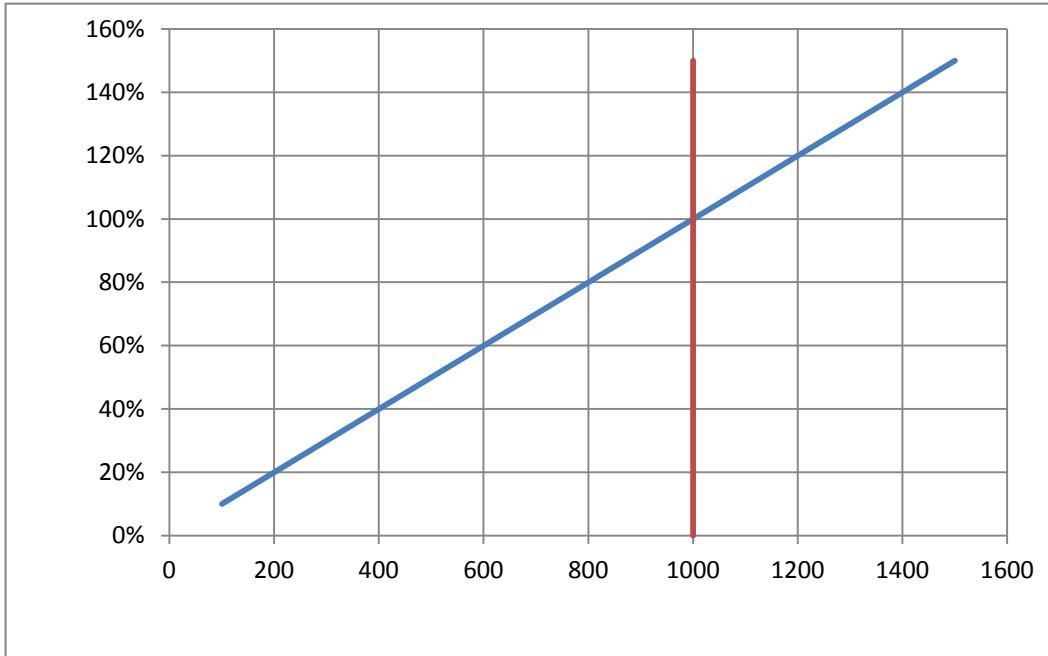
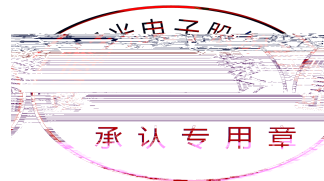

Fig 1-7 Forward Current Vs. Relative Intensity



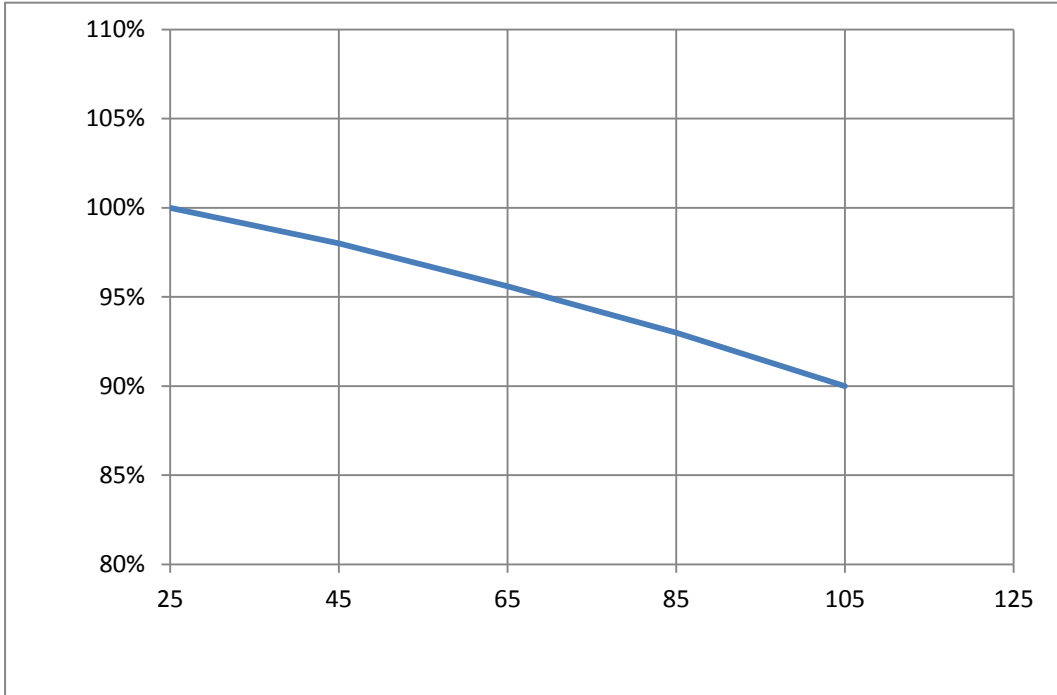

Fig 1-8 Ts Temperature Vs Relative Intensity

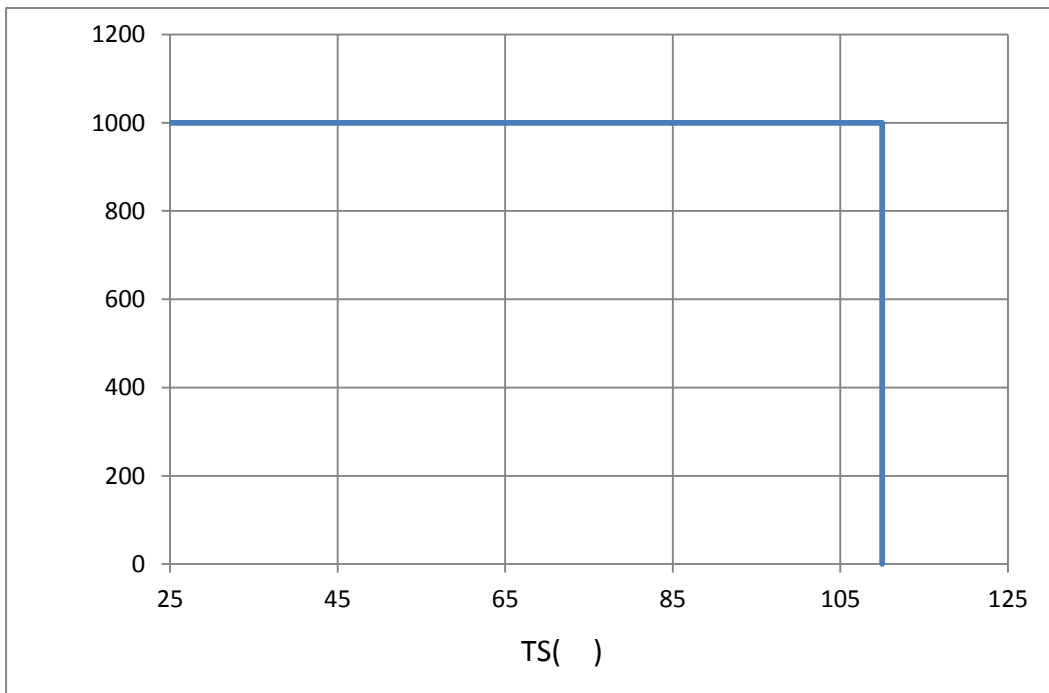

Fig 1-11 Ts Temperature Vs Forward Current

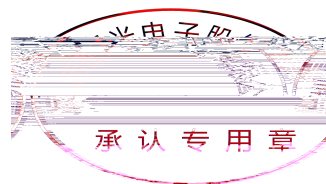

Fig. 1-11 Forward Voltage Vs Solder Temperature



Fig 1-10 Radiation diagram

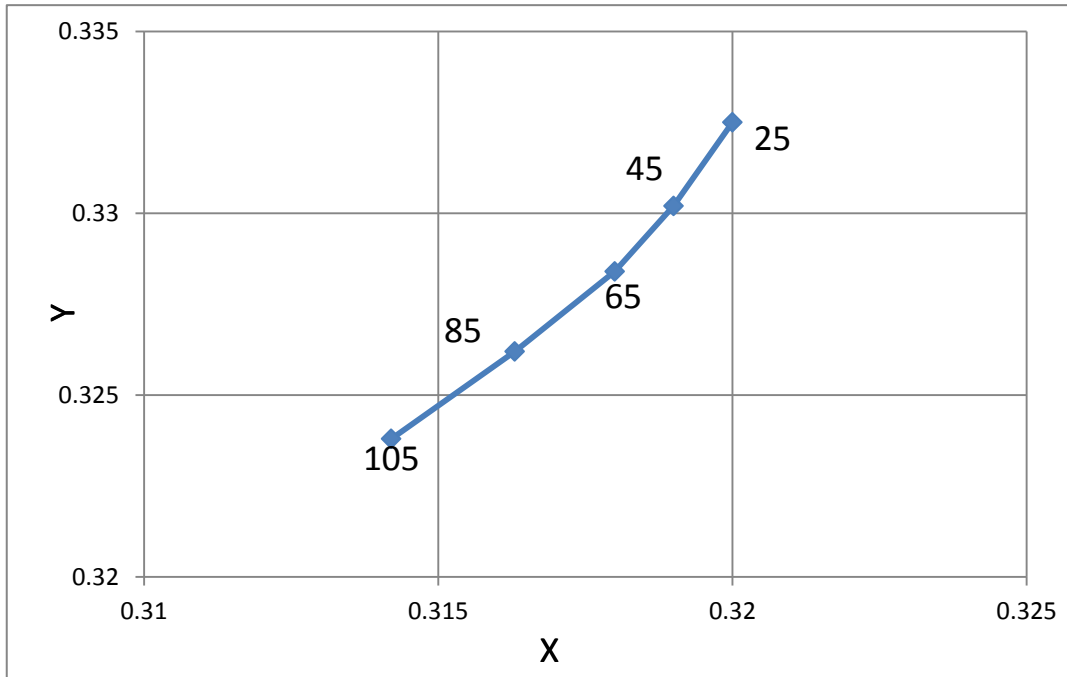

Fig. 1-13 Chromaticity Coordinate Vs Solder Temperature

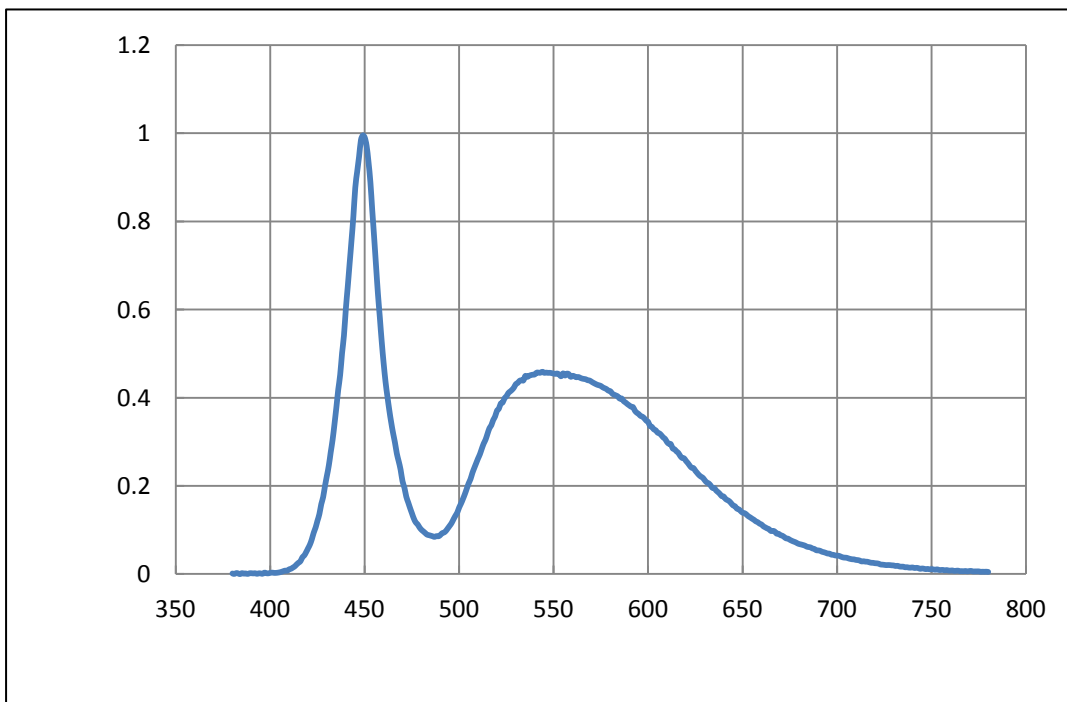
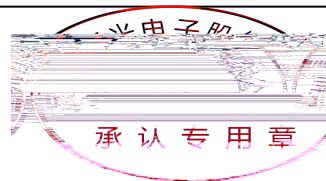

Fig 1-9 Spectrum Distribution



2. Packaging

2.1 Packaging Specification

Package:4000pcs/reel. 4000pcs

2.1.1 Carrier Tape Dimension

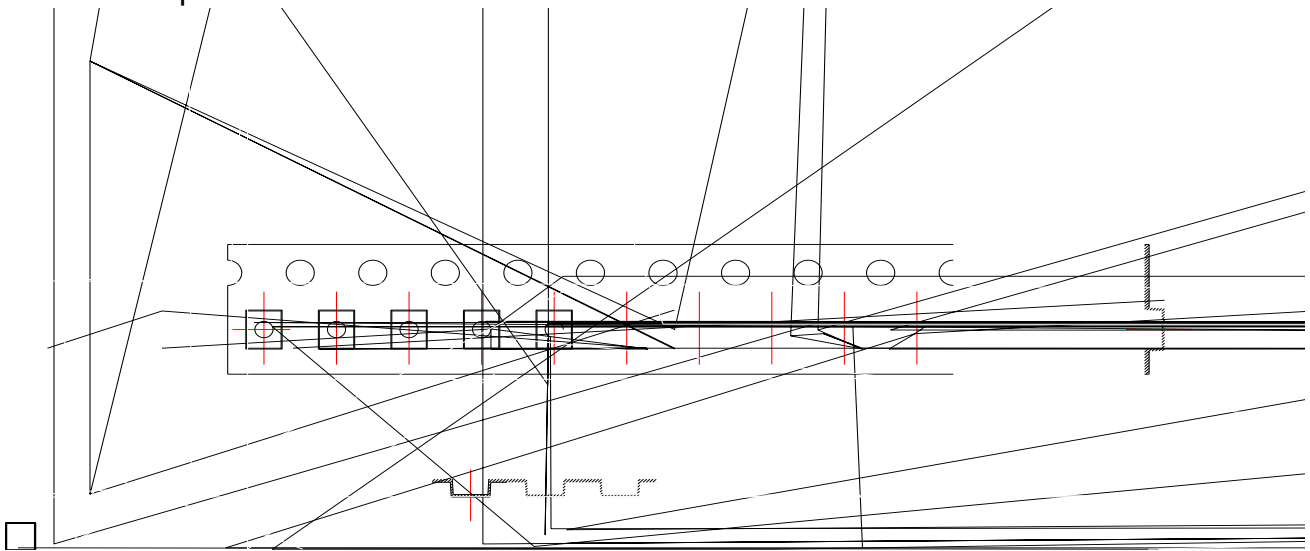

Fig.2-1 Carrier Tape Dimension

2.1.2 Reel Dimension

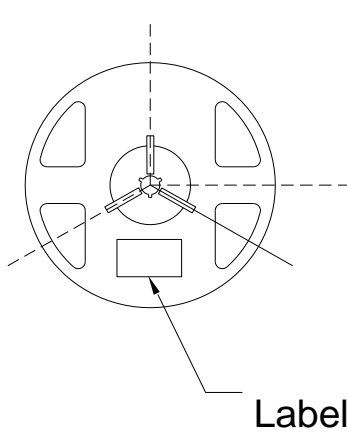

Fig.2-2 Reel Dimension

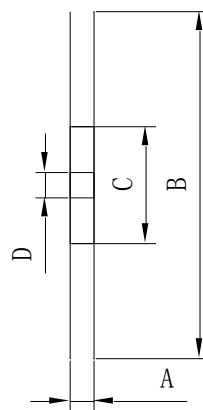
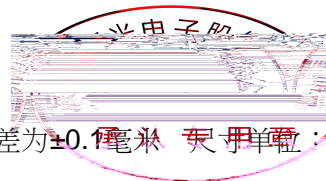

Table 2-1 Dimension

A	11.4± 0.3mm
B	180±2mm
C	60.0±1mm
D	13.0±0.2mm

Notes

The tolerances unless mentioned ± 0.1 mm. Unit : mm 注：未注公差为 ± 0.1 毫米 英寸单位：毫米



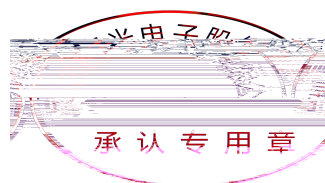

2.4 Reliability Test Items And Conditions

Table 2-3 Reliability Test Items And Conditions

Test Items	Ref.Standard	Test Condition	Time	Quantity	Ac/Re /
Reflow Soldering	JEITA ED-4701 300 301	Temp:260 max T=10 sec Precondition:85 , 85%RH 168Hrs	3times.	10Pcs.	0/1
Temperature Cycle	JESD22-A104	125 30 min. -40 30 min.	1000Cycles	10Pcs.	0/1
Thermal Shock	JESD22-A106	-40 15min 10sec 125 15min	1000Cycles	10Pcs.	0/1
High Temperature Storage	JESD22-A103	Temp.:125	1000Hrs.	10Pcs.	0/1
Low Temperature Storage	JESD22-A119	Temp.: -40	1000Hrs.	10Pcs.	0/1
Life Test	JESD22-A108	Ta=25 IF=1000mA	1000Hrs.	10Pcs.	0/1
High Temperature Life Test	JESD22-A108	Ta=105 IF=1000mA	1000Hrs.	10Pcs.	0/1
High Temperature High Humidity Life Test	JESD22-A101	85 / 85%RH IF=1000mA	1000Hrs.	10Pcs.	0/1
Low Temperature Life Test	JESD22-A108	Ta=-40 IF=1000mA	1000Hrs.	10Pcs.	0/1

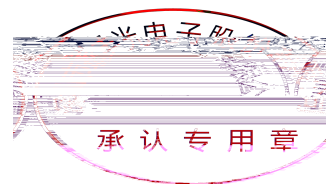

2.5 Criteria For Judging Damage

Table Criteria For Judging Damage

Test Items	Symbol	Test Condition	Criteria For Judgement	
			Min.	Max.
Forward Voltage	V_F	$I_F=1000\text{mA}$	-	U.S.L*)x1.1
Reverse Current	I_R	$V_R = 5V$	-	U.S.L*)x2.0
Luminous Flux		$I_F=1000\text{mA}$	L.S.L*)x0.7	-

Notes

- 1.U.S.L: Upper standard level L.S.L: Lower standard level
2. The above reliability tests is based on the verification of a single/strip LED of Refond's existing experimental platform, the reliability experiment was taken under good heat dissipation conditions. when customers applies the LED to the series and parallel circuit, should take consideration of all the factors such as the current, voltage distribution, heat dissipation and others. / LED

LED

3. SMT Reflow Soldering Instructions SMT

3.1 SMT Reflow Soldering Instructions SMT

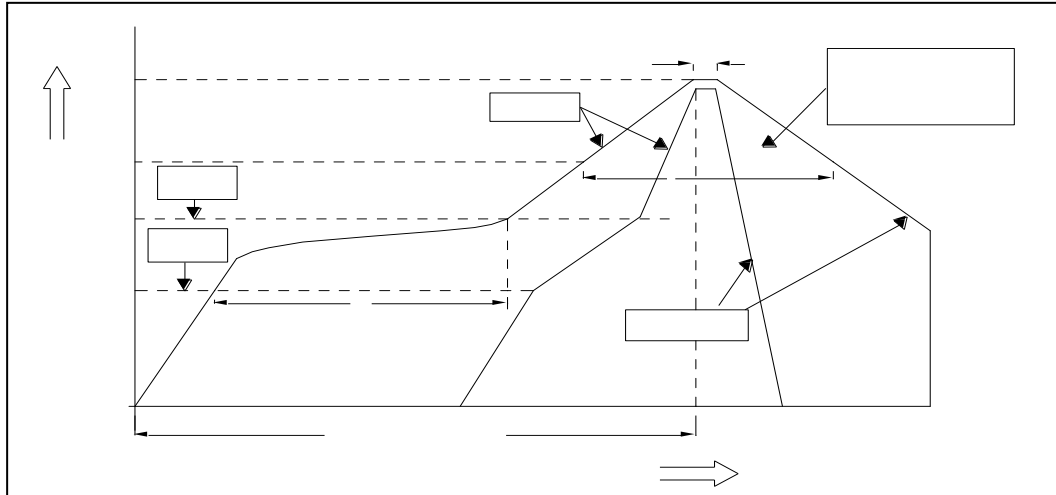
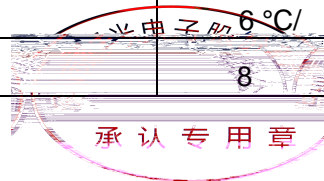

Fig.3-1 SMT Reflow Soldering Instructions SMT

Table 3-1 SMT Reflow Soldering Instructions SMT

Average temperature rise speed	T_{smax}	T_P	3 °C/	Max 3 °C/ s
Preheating: minimum temperature	(Tsmín)		150 °C	
Preheating: Max temperature	(Tsmáx)		200 °C	
Preheating: Time	Tsmín	Tsmáx	60 - 120	60s-120s
Time limited to maintain high temperature: the temperature (TL)			217 °C	
Time limited to maintain high temperature: The Time (TL)			60	Max 60s
Peak /Classification of temperature /	(TP)		260 °C	
Time limit classification of peak temperature time			10	Max 10s
Hold time within 5 ° C with the actual peak temperature (TP) (TP) 5 °C			30	Max 30s
Cooling speed			6 °C/	Max 6 °C/ s
Needed time from 25 °C to T_P 25 °C			8	Max 8 minutes



Notes

(1) Reflow soldering should not be done more than two times. In the case of more than 24 hours passed soldering after first, LEDs will be damaged. 24

LED

(2) When soldering , do not put stress on the LEDs during heating.

3.1.1 Soldering Iron

(1) When hand soldering, keep the temperature of iron below less 300°C less than 3 seconds

300 3

(2) The hand solder should be done only one time.

3.1.2 Repairing

Repair should not be done after the LEDs have been soldered. When repairing is unavoidable,a double-head soldering iron should be used (as below figure). It should be confirmed in advance whether the characteristics of LEDs will or will not be damaged by repairing.

LED

LED

3.1.3 Cautions

(1) The encapsulated material of the LEDs is silicone. Therefore the LEDs have a soft surface on the top of package. The pressure to the top surface will be influence to the reliability of the LEDs. Precautions should be taken to avoid the strong pressure on the encapsulated part. So when use the picking up nozzle, the pressure on the silicone resin should be proper. LED LED

(2) Components should not be mounted on warped (non coplanar) portion of PCB. After soldering, do not warp the circuit board.LED PCB

(3) Do not apply mechanical force or excess vibration during the cooling process to normal temperature after soldering. Do not rapidly cool device after soldering.

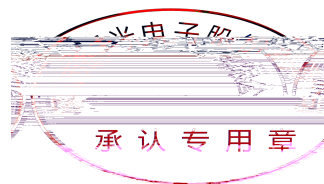

4. Handling Precautions

(1) LED operating environment and sulfur element composition cannot be over 100PPM in the LED mating usage material. This is provided for informational purposes only and is not a warranty or endorsement.

LED

100PPM.

(2) In order to prevent external material from getting into the inside of LED, which may cause the malfunction of LED, the single content of Bromine element is required to be less than 900PPM, the single content of Chlorine element is required to be less than 900PPM, the total content of Bromine element and Chlorine element in the external materials of the application products is required to be less than 1500PPM. This is provided for informational purposes only and is not a warranty or endorsement.

LED

900PPM

900PPM

1500PPM.

(3) VOCs (Volatile organic compounds) emitted from materials used in the construction of fixtures can penetrate silicone encapsulants of LEDs and discolor when exposed to heat and photonic energy. The result can be a significant loss of light output from the fixture. Knowledge of the properties of the materials selected to be used in the construction of fixtures can help prevent these issues. Refond advises against the use of any chemicals or materials that have been found or are suspected to have an adverse affect on device performance or reliability. To verify compatibility, Refond recommends that all chemicals and materials be tested in the specific application and environment for which they are intended to be used. Attaching LEDs, do not use adhesives that outgas organic vapor.

LED

LED

LED

LED

(4) Handle the component along the side surface by using forceps or appropriate tools; do not directly touch or Handle the silicone lens surface, it may damage the internal circuitry.

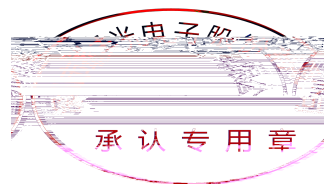

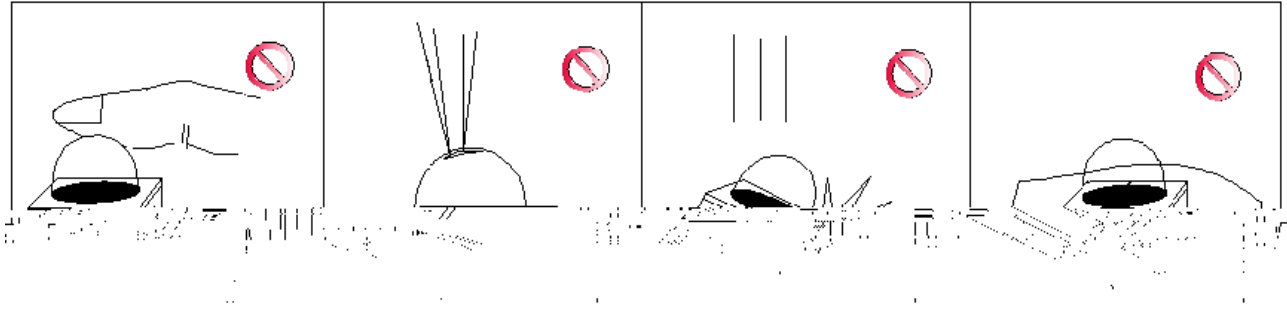

Fig 4-1

(5) In designing a circuit, the current through each LED must not exceed the absolute maximum rating specified for each LED. In the meanwhile, resistors for protection should be applied, otherwise slight voltage shift will cause big current change, burn out may happen. The driving circuit must be designed to allow forward voltage only when it is ON or OFF. If the reverse voltage is applied to LED, migration can be generated resulting in LED damage.

LED

LED

(6) Thermal Design is paramount importance because heat generation may result in the Characteristics decline, such as brightness decreased, Color change and so on. Please consider the heat generation of the LEDs when making the system design.

LED

(7) Compared to standard encapsulants, silicone is generally softer, and the surface is more likely to attract dust, requiring special care during processing. In cases where a minimal level of dirt and dust particles cannot be guaranteed, a suitable cleaning solution must be applied to the surface after the soldering of components. Refond suggests using isopropyl alcohol for cleaning. In case other solvents are used, it must be assured that these solvents do not dissolve the package or resin. Ultrasonic cleaning is not recommended. Ultrasonic cleaning may cause damage to the LED.

LED

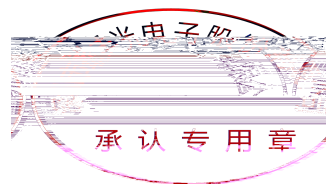



www.refond.com

Declare

This specification is written both in English and in Chinese and the latter is formal.

