

Contents

1. Description	3
1.1 General Description	3
1.2 Features	3
1.3 Application	3
1.4 Package Dimension	4
1.5 Product Parameters	5
1.5 Bin Range Of Forward Voltage and Luminous Flux (IF=30mA)	BIN
(IF=30mA)	8
1.6 Typical optical characteristics curves	11
2. Packaging	15
2.1 Packaging Specification	15
2.1.1 Carrier Tape Dimension	15
2.1.2 Reel Dimension	15
2.1.3 Label Form Specification	16
2.2 Moisture Resistant Packing	16
2.3 Cardboard Box	16
2.4 Reliability Test Items And Conditions	17
2.5 Criteria For Judging Damage	18
3. SMT Reflow Soldering Instructions SMT	19
3.1 SMT Reflow Soldering Instructions SMT	19
4. Handling Precautions	21
4.1 Handling Precautions	21

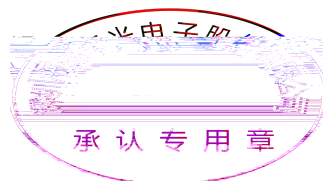

1. Description

1.1

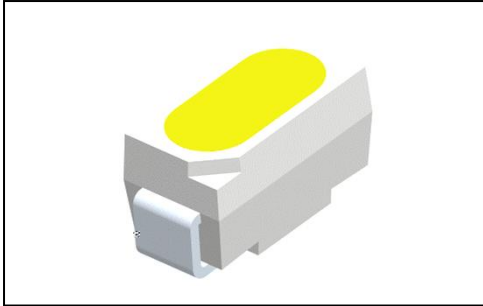

The White LED which was fabricated using a blue chip and the phosphor package dimension:2.10mmX1.00mmX1.10mm

LED

2.10mmX1.00mmX1.10mm

1.2 Features

- ▶ PLCC-2 Package.PLCC-2
- ▶ Extremely wide viewing angle.
- ▶ Suitable for all SMT assembly and solder process. SMT
- ▶ Available on tape and reel.
- ▶ Moisture sensitivity level: Level 3. Level 3
- ▶ RoHS compliant. RoHS

1.3 Application

- ▶ Decorative lighting, amp belt.
- ▶ Optical indicator.
- ▶ General use.

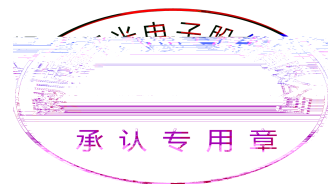

1.4 Package Dimension

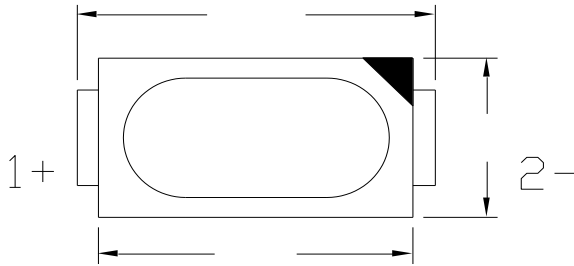

Fig.1-1 Top view

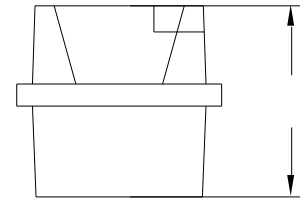

Fig.1-2 Side view

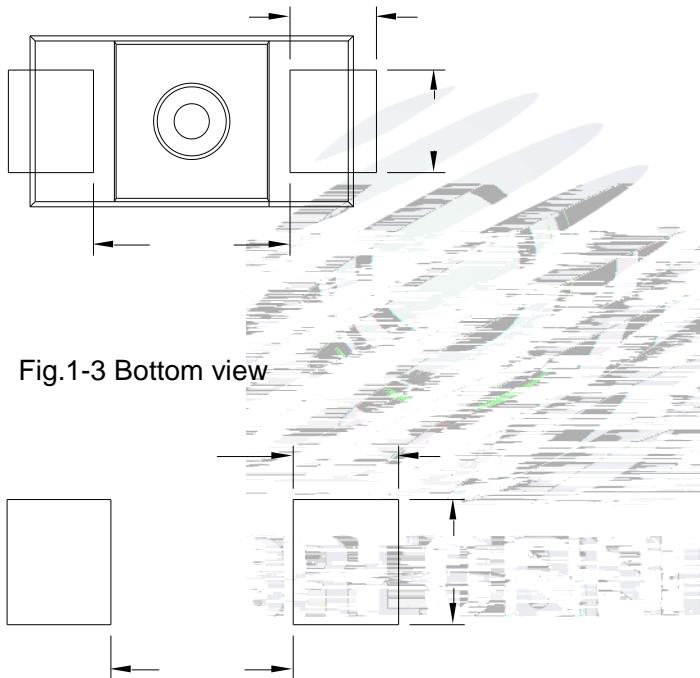

Fig.1-3 Bottom view

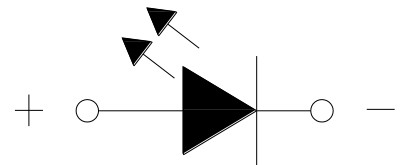
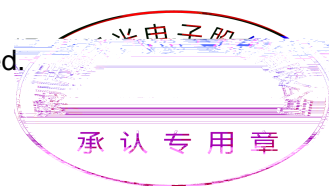

Fig.1-4 Polarity

Fig.1-5 Soldering patterns

Notes

1. All dimensions units are millimeters.
2. All dimensions tolerances are $\pm 0.20\text{mm}$ unless otherwise noted.



0.20

1.5 Product Parameters

Table 1-1 Electrical / Optical Characteristics at Ts=25°C

Item	Symbol	Test Condition	Value			Unit
			Min.	Typ	Max.	
Forward Voltage	V_F	$I_F=30\text{mA}$	2.7	---	3.5	V
Reverse Current	I_R	$V_R=5\text{V}$	---	---	10	μA
Luminous flux	Φ	I_F	---	---	---	lm
RF-17TK10DS-EC-F-Y (1625K-1725K)	Φ	$I_F=30\text{mA}$	4	---	8	lm
RF-18TK10DS-EC-F-Y (1725K-1875K)	Φ	$I_F=30\text{mA}$	4	---	8	lm
RF-20TK10DS-EC-F-Y (1900K-2100K)	Φ	$I_F=30\text{mA}$	5	---	9	lm
RF-27TK10DS-EC-F-Y (2600K-2800K)	Φ	$I_F=30\text{mA}$	7	---	11	lm
RF-30TK10DS-EC-F-Y (2900K-3100K)	Φ	$I_F=30\text{mA}$	7	---	11	lm
RF-35TK10DS-EC-F-Y (3350K-3650K)	Φ	$I_F=30\text{mA}$	7	---	11	lm
RF-40TK10DS-EC-F-Y (3800K-4200K)	Φ	$I_F=30\text{mA}$	8	---	12	lm
RF-50TK10DS-EC-F-Y (4750K-5250K)	Φ	$I_F=30\text{mA}$	8	---	12	lm
RF-60TK10DS-EC-F-Y (5675K-6325K)	Φ	$I_F=30\text{mA}$	8	---	12	lm
RF-65TK10DS-EC-F-Y (6250K-6750)	Φ	$I_F=30\text{mA}$	8	---	12	lm

RF-K32TK10DS-EC-F-Y (3050K-3350K)	Φ	I _F =30mA	7	---	11	lm
RF-K37TK10DS-EC-F-Y (3600K-3900K)	Φ	I _F =30mA	7	---	11	lm
RF-K42TK10DS-EC-F-Y (4050K-4350K)	Φ	I _F =30mA	7	---	11	lm
RF-K45TK10DS-EC-F-Y (4300K-4600K)	Φ	I _F =30mA	7	---	11	lm
RF-K47TK10DS-EC-F-Y (4600K-4900K)	Φ	I _F =30mA	7	---	11	lm
Color Rendering Index ()	R _a	I _F =30mA	90	---	---	---
Viewing Angle	2θ _{1/2}	I _F =30mA	---	115.6	---	deg
Thermal Resistance.	R _{THJ-S}	I _F =30mA	---	70	---	/W

Table 1-2 Absolute Maximum Ratings at Ts=25°C

Parameter	Symbol	Rating	Units
Power Dissipation	P _D	105	mW
Forward Current	I _F	30	mA
Peak Forward Current	I _{FP}	100	mA
Reverse Voltage	V _R	5	V
Electrostatic Discharge (HBM)	E _{SD}	2000	V
Operating Temperature	T _{OPR}	-40 ~ +85	
Storage Temperature	T _{OPR}	-40 ~ +100	
Junction Temperature	T _J		

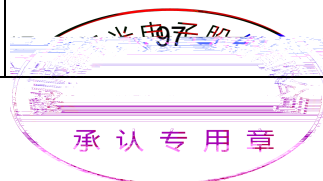

Notes

1. 1/10 Duty cycle, 0.1ms pulse width. 0.1ms, 1/10.
2. The above forward voltage measurement allowance tolerance is $\pm 0.1V$.
3. The above color coordinates measurement allowance tolerance is ± 0.005 . 0.005.
4. The above luminous intensity measurement allowance tolerance $\pm 10\%$.
5. The above Color Rending Index measurement allowance tolerance is ± 1 . Ra ± 1 .
6. Care is to be taken that power dissipation does not exceed the absolute maximum rating of the product.
7. All measurements were made under the standardized environment of Refond.
8. When the LEDs are in operation the maximum current should be decided after measuring the package temperature, junction temperature should not exceed the maximum rate. LED

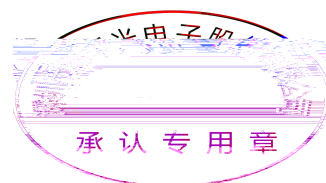
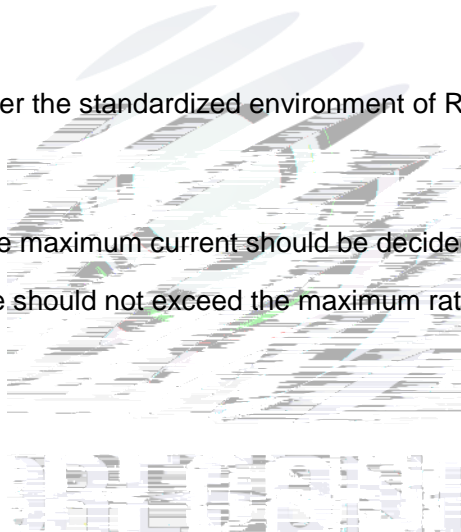

1.5 Bin Range Of Forward Voltage and Luminous Flux (If=30mA)

BIN (If=30mA)

Table 1-3

V_F V	F2	G1	G2	H1	H2	I1	I2	J1
	2.7-2.8	2.8-2.9						

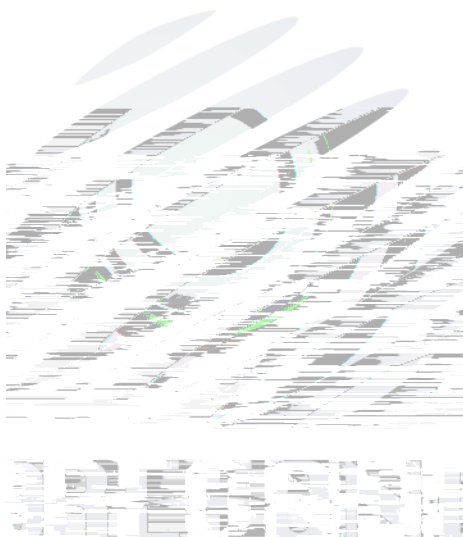

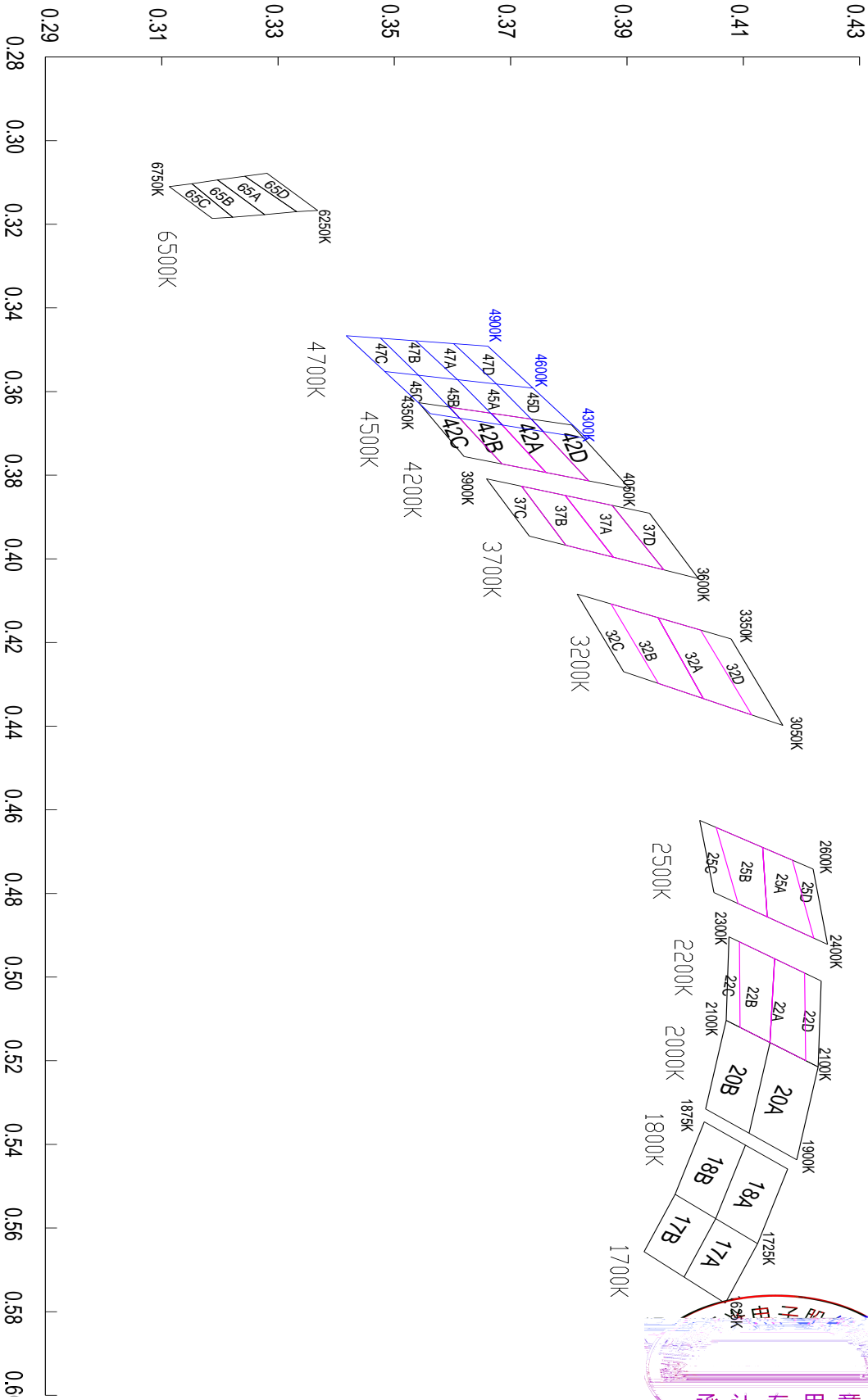

Fig 1-7 The C.I.E Chromaticity Diagram CIE

BIN	X1	Y1	X2	Y2	X3	Y3	X4	Y4
17A	0.5637	0.4124	0.5780	0.4069	0.5717	0.3998	0.5578	0.4053
17B	0.5578	0.4053	0.5717	0.3998	0.5657	0.3929	0.5519	0.3983
18A	0.5459	0.4176	0.5637	0.4124	0.5578	0.4053	0.5402	0.4104
18B	0.5402	0.4104	0.5578	0.4053	0.5519	0.3983	0.5346	0.4033
20A	0.5215	0.4229	0.5437	0.4192	0.5373	0.4110	0.5156	0.4146
20B	0.5156	0.4146	0.5373	0.4110	0.5315	0.4035	0.5104	0.4071
22A	0.4956	0.4154	0.4990	0.4205	0.5200	0.4207	0.5157	0.4146
	0.4916	0.4093	0.4956	0.4154	0.5156	0.4146	0.5120	



1.6 Typical optical characteristics curves

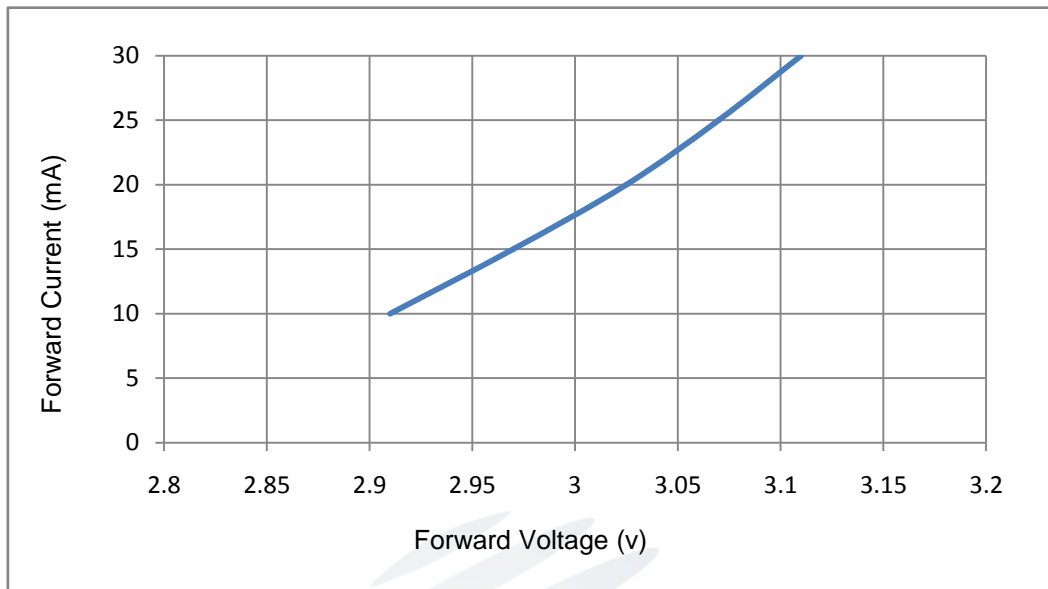

Fig 1-8 Forward Voltage Vs. Forward Current

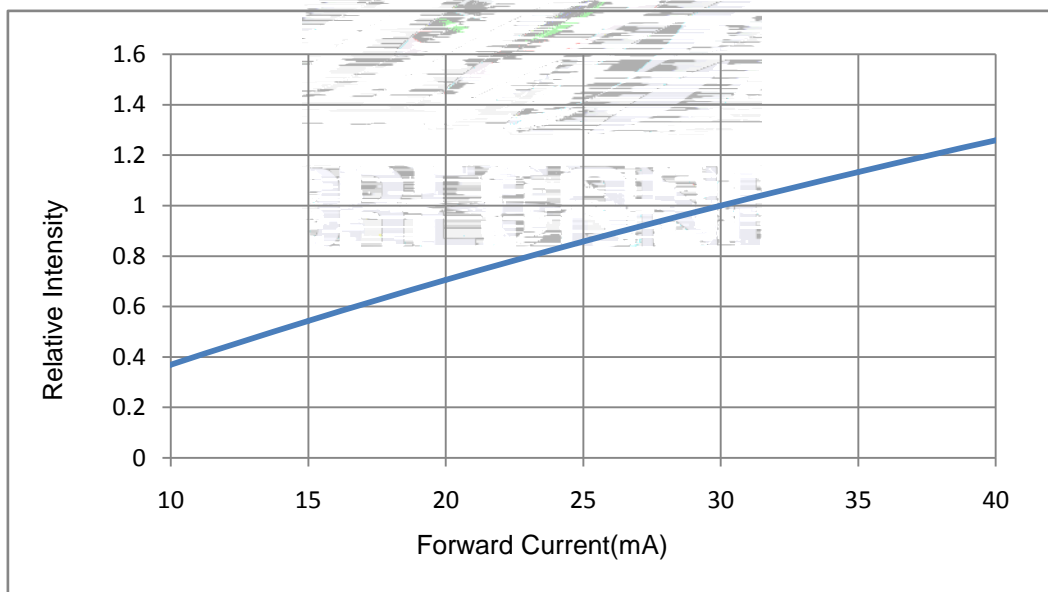
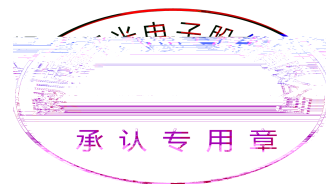

Fig 1-9 Forward Current Vs. Relative Intensity



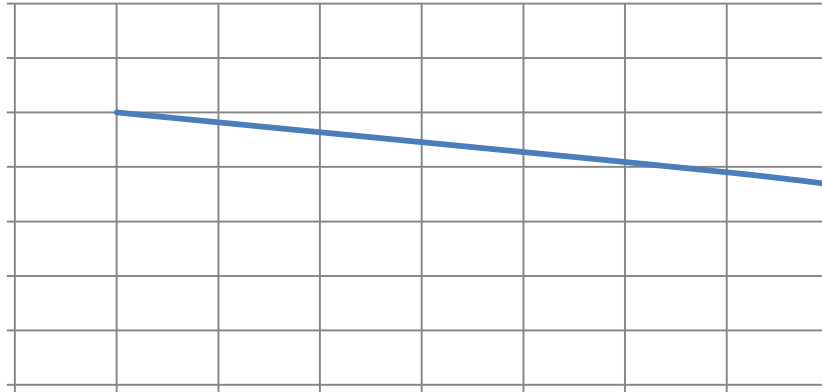

Fig 1-10 Solder Temperature Vs Relative Intensity

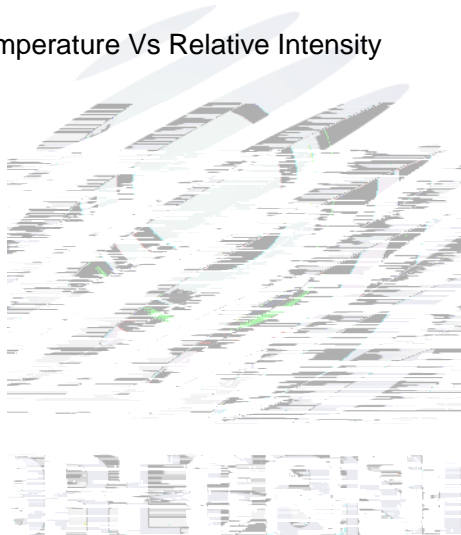

Fig 1-11 Solder Temperature Vs Forward Current

Tj 97

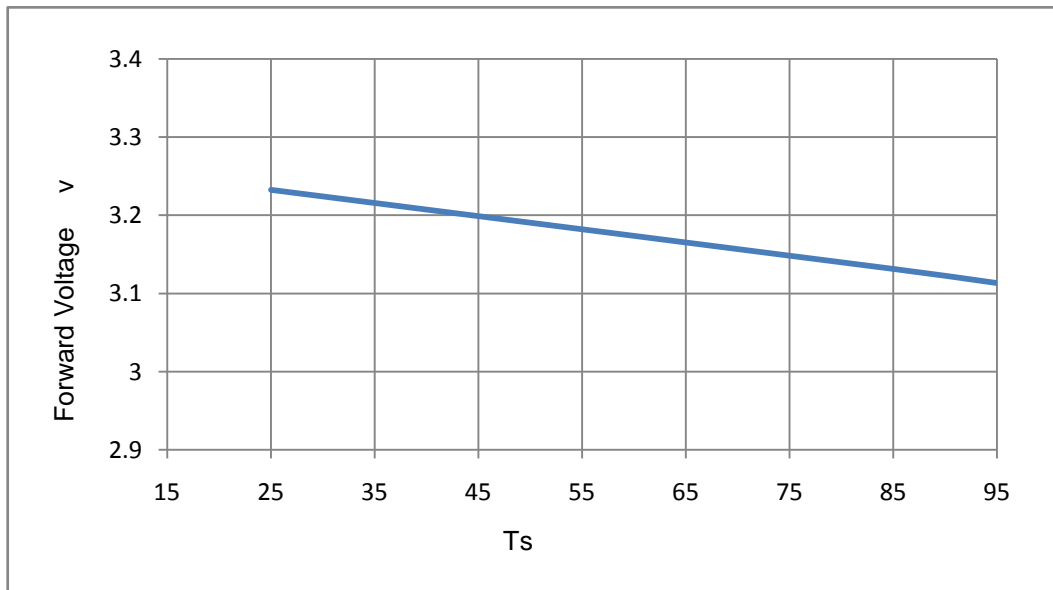

Fig 1-12 Forward Voltage Vs Solder Temperature

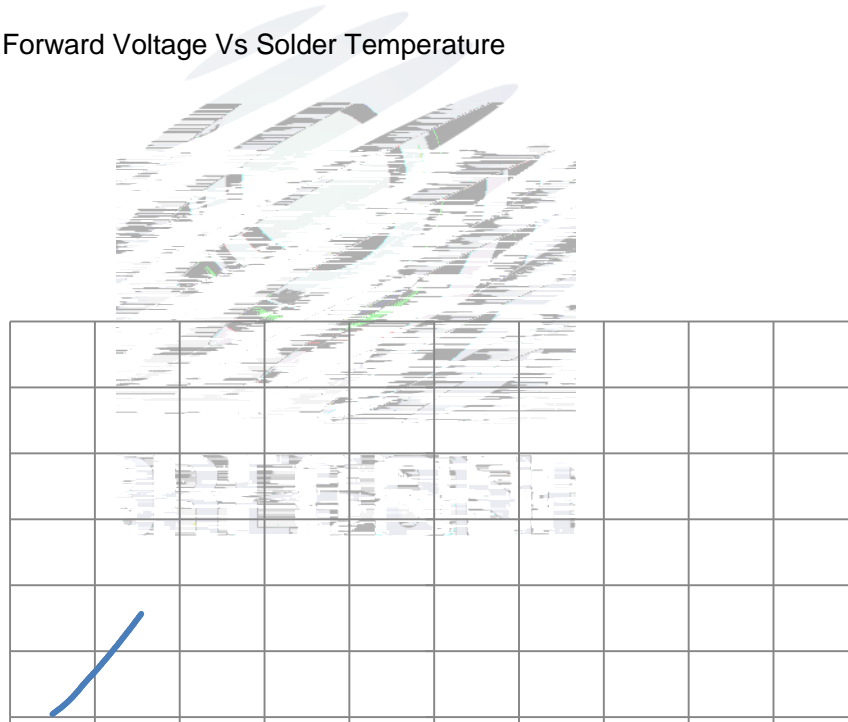

Fig 1-13 Radiation diagram

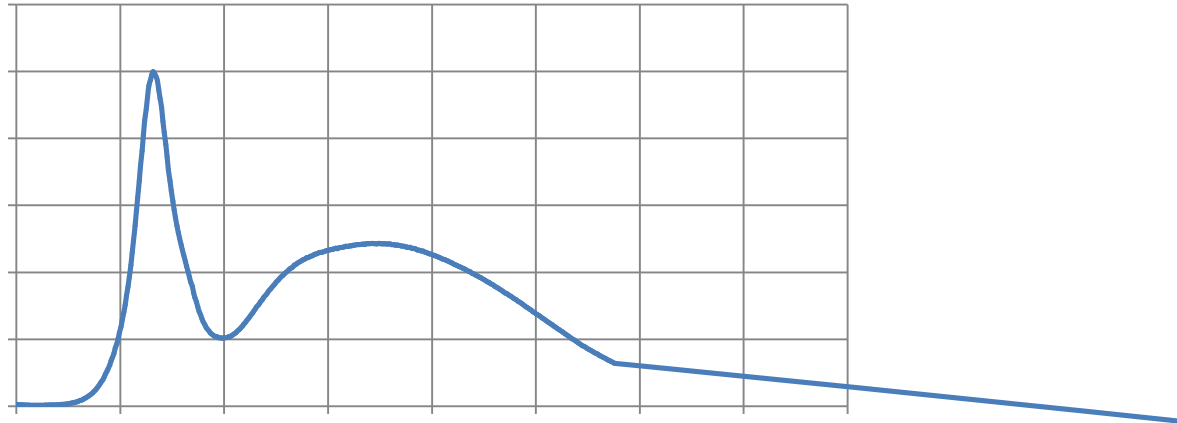
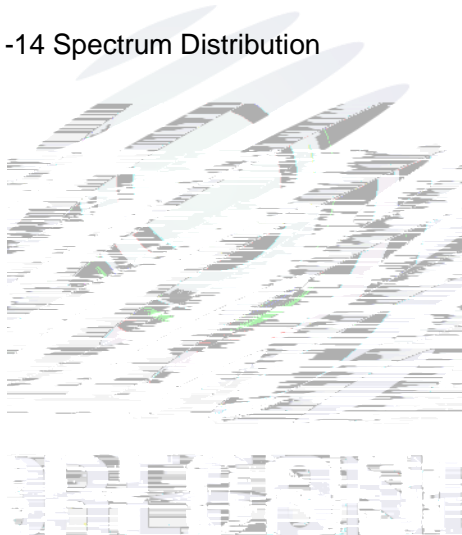

Fig 1-14 Spectrum Distribution



2. Packaging

2.1 Packaging Specification

Package:3000pcs/reel max,300pcs/reel min.

3000pcs

300pcs

2.1.1 Carrier Tape Dimension

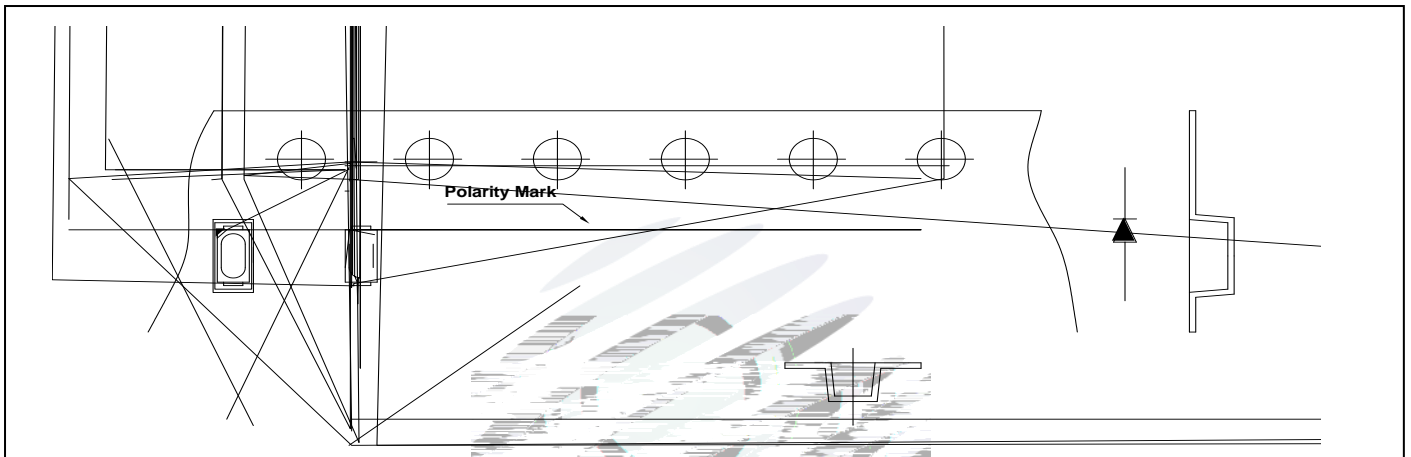

Fig.2-1 Carrier Tape Dimension

2.1.2 Reel Dimension

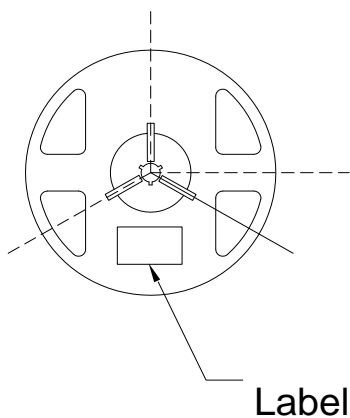

Fig.2-2 Reel

Table 2-1 Reel Dimension

A	12 0.1mm
B	178 1mm
C	60 1mm
D	13.0 0.5mm

Notes

The tolerances unless mentioned $\pm 0.1\text{mm}$. Unit : mm

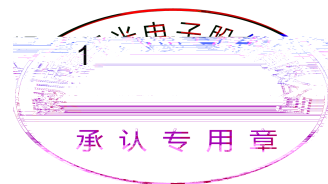

2.1.3 Label Form Specification

PART NO.	
SPEC NO.	
LOT NO.	
BIN CODE	
Φ	XY
V _F	
	QTY:
	DATE:

Table 2-2 Label Parameter

PART NO.	Part Number
SPEC NO.	Spec Number
LOT NO.	Lot Number
BIN CODE	Bin Code
Φ	Luminous flux
XY	Chromaticity Bin
V _F	Forward Voltage
QTY	Packing Quantity
DATE	Made Date

Fig 2-3 Label Form

2.2 Moisture Resistant Packing

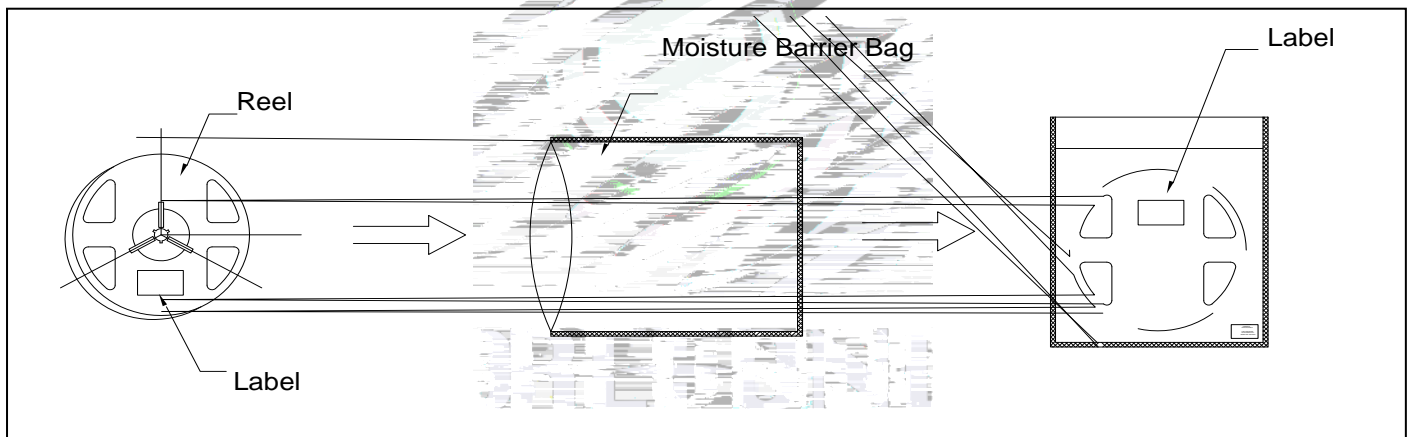

Fig.2- Packing specification

2.3 Cardboard Box

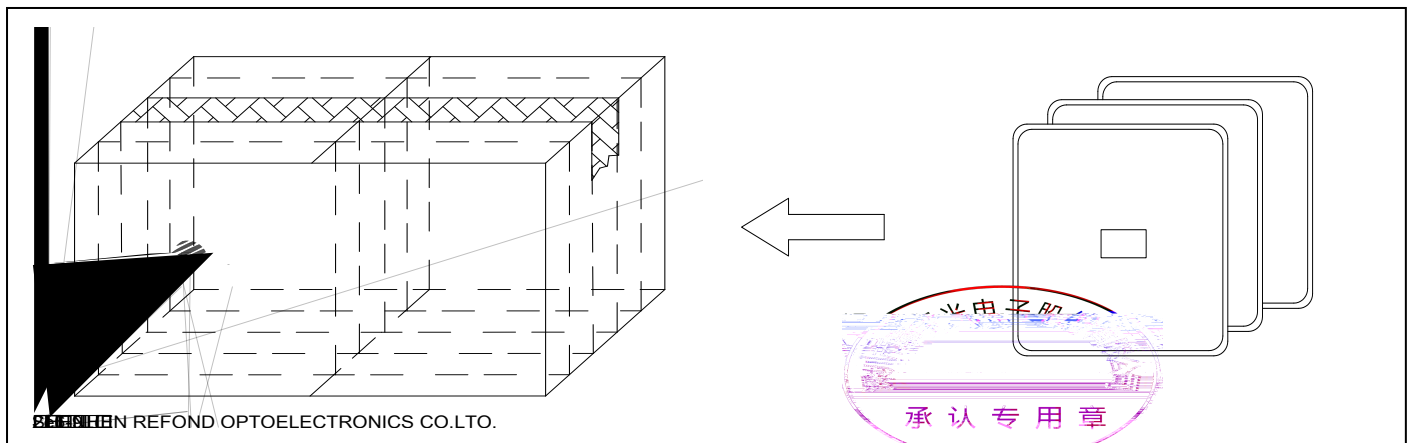

Fig.2- Cardboard Box

2.4 Reliability Test Items And Conditions

Table 2-3 Test items and conditions

Test Items	Ref. Standard	Test Condition	Time	Quantity	Ac/Re
					/

Reflow

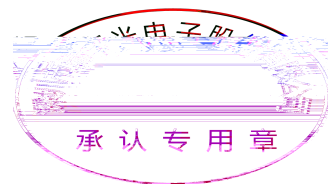

2.5

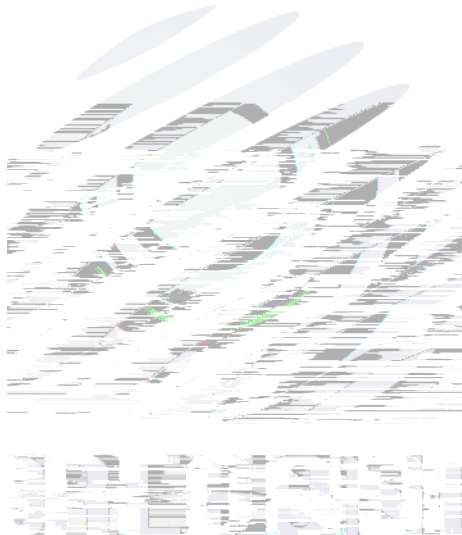

3. SMT Reflow Soldering Instructions SMT

3.1 SMT Reflow Soldering Instructions SMT

Fig.3-1 SMT Reflow Soldering Instructions SMT

Table 3-1 SMT Reflow Soldering Parameter

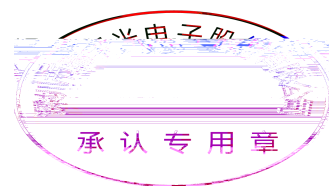
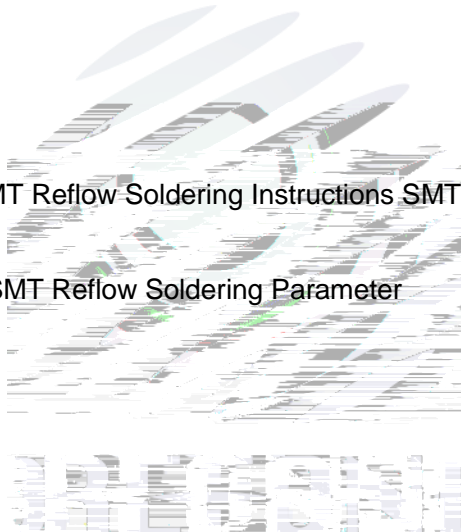



(3) Do not apply mechanical force or excess vibration during the cooling process to normal temperature after soldering. Do not rapidly cool device after soldering.

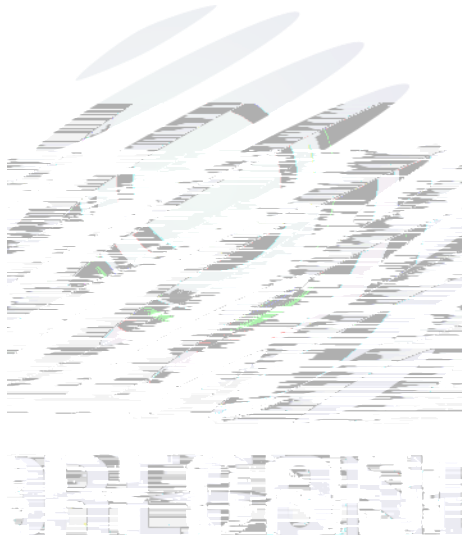



In case other solvents are used, it must be assured that these solvents do not dissolve the package or resin. Ultrasonic cleaning is not recommended. Ultrasonic cleaning may cause damage to the LED.

LED

Table 4-1 Storage

Conditions		Temperature	Humidity	Time
Storage	Before Opening Aluminum Bag	30	75%	Within 6 Months From Date 6
	After Opening Aluminum Bag	30	60%	24hours 24
Baking		60 ± 5	-	24hours 24

(8) If the moisture absorbent material (silica gel) has faded away or the LEDs have exceeded the storage time , baking treatment should be performed after unpacking and based on the following condition (60±5) °C for above 24 hours.

60 ± 5 24

If the package is flatulence or damaged, please notify the sales staff to assist.

(9) Similar to most Solid state devices; LEDs are sensitive to Electro-Static Discharge (ESD) and Electrical Over Stress (EOS).

(10) Other points for attention, please refer to our relevant information.

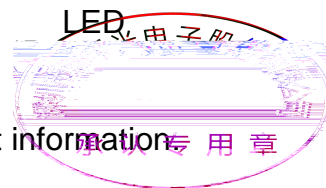

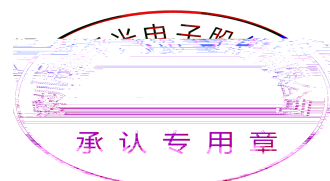

Declare

This specification is written both in English and in Chinese and the latter is formal.