

# SPECIFICATION

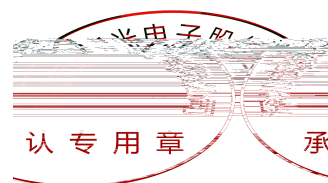

# Contents

1. Description	
1.1 General Description .....	3
1.2 Features .....	3
1.3 Application .....	3
1.4 Package Dimension .....	4
1.5 Product Parameters .....	5
1.6 Typical optical characteristics curves .....	6
2. Packaging	
2.1 Packaging Specification .....	9
2.1.1 Carrier Tape Dimension .....	9
2.1.2 Reel Dimension .....	10
2.1.3 Label Form Specification .....	10
2.2 Moisture Resistant Packing .....	11
2.3 Cardboard Box .....	11
2.4 Reliability Test Items And Conditions .....	12
2.5 Criteria For Judging Damage .....	12
3. SMT Reflow Soldering Instructions SMT	
3.1 SMT Reflow Soldering Instructions SMT .....	13
3.1.1 Soldering Iron .....	14
3.1.2 Repairing .....	14
3.1.3 Cautions .....	15
4. Handling Precautions	
4.1 Handling Precautions	

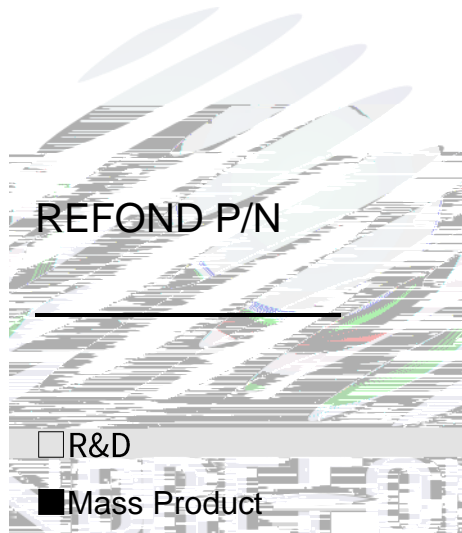
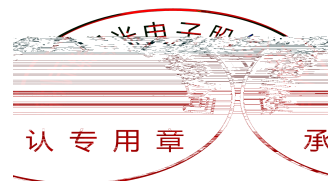

## 1. Description

### 1.1 General Description

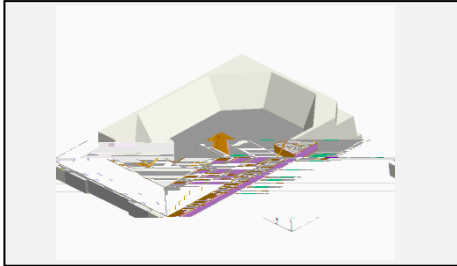

This production use the PLCC-2 package outline size 2.8\*3.5\*0.65mm

### 1.2 Features

- ▶ PLCC package.
- ▶ Viewing angle:120°.
- ▶ Suitable for all SMT assembly and solder process.
- ▶ Available on tape and reel.
- ▶ Moisture sensitivity level: Level 3.
- ▶ RoHS compliant.

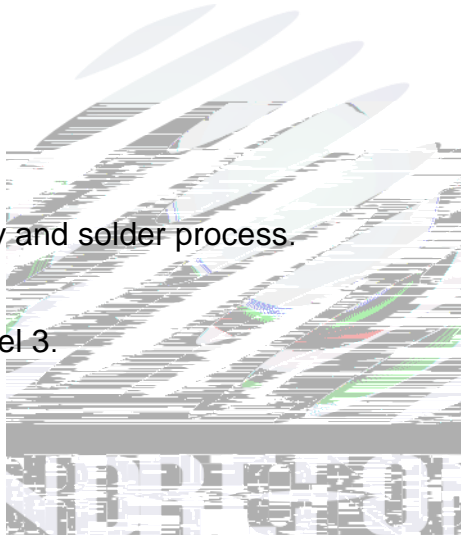

### 1.3 Application

- ▶ Flower production.
- ▶ Tissue culture.
- ▶ Plant factory.
- ▶ Refreshment.
- ▶ General use.

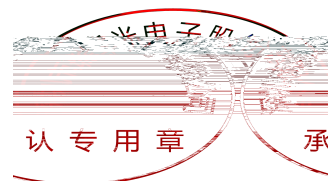

## 1.4 Package Dimension

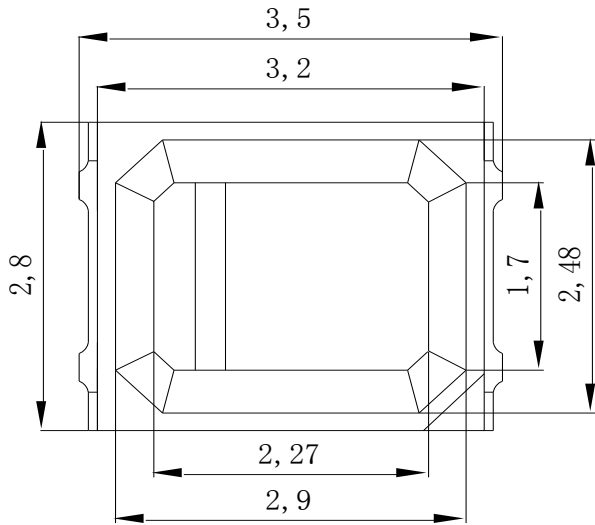

Fig.1-1 Top view

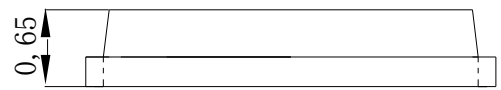

Fig.1-2 Side view

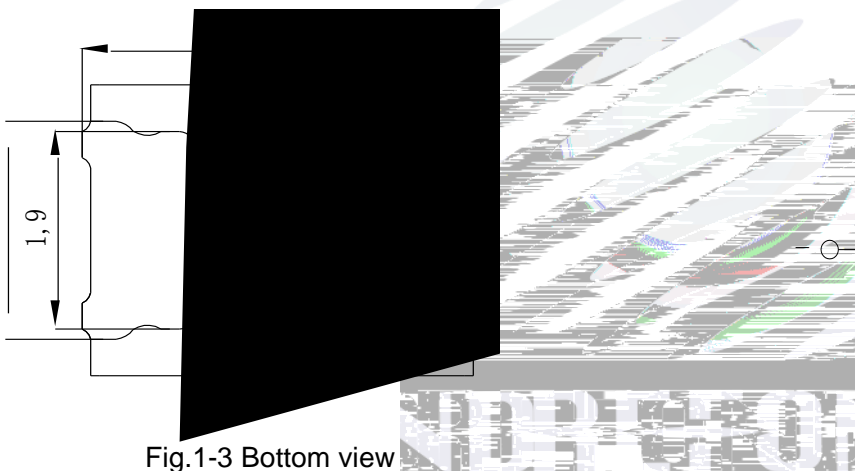

Fig.1-3 Bottom view

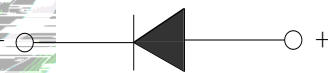

Fig.1-4 Polarity

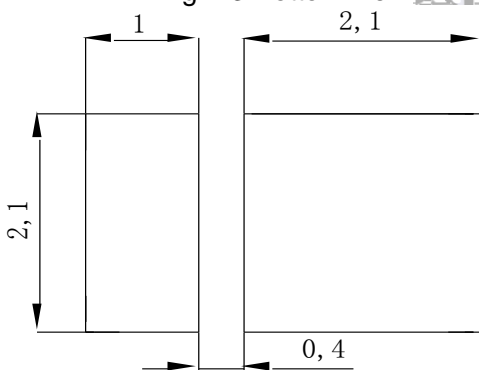
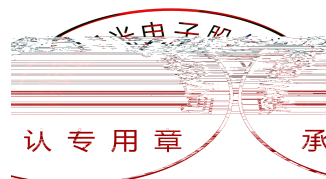

Fig.1-5 Soldering patterns

### Notes:

1. All dimensions units are millimeters.
2. All dimensions tolerances are  $\pm 0.2\text{mm}$  unless otherwise noted.



## 1.5 Product Parameters

Table 1-1 Electrical / Optical Characteristics at Ts=25°C

Item	Symbol	Test Condition	Value			Unit
			Min.	Typ	Max.	
Forward Voltage	$V_F$	$I_F=150\text{mA}$	1.8	2.2	2.4	V
Reverse Current	$I_R$	$V_R=5\text{V}$	---	---	10	$\mu\text{A}$
Total radiant flux	$\Phi_e$	$I_F=150\text{mA}$	90	112	---	mW
Peak wavelength	$\lambda_p$	$I_F=150\text{mA}$	628	633	638	nm
Viewing Angle	2 $\theta$ 1/2	$I_F=150\text{mA}$	---	120	---	deg
Thermal Resistance.	$R_{THJ-S}$	$I_F=150\text{mA}$	---	15	---	$^{\circ}\text{C}/\text{W}$

Table 1-2 Absolute Maximum Ratings at Ts=25°C

Parameter	Symbol	Rating	Units
Power Dissipation	$P_D$	0.3	W
Forward Current	$I_F$	150	mA
Peak Forward Current	$I_{FP}$	200	mA
Reverse Voltage	$V_R$	5	V
Electrostatic Discharge (HBM)	$E_{SD}$	2000	V
Operating Temperature	$T_{OPR}$	-40 ~ +85	
Storage Temperature	$T_{OPR}$	-40 ~ +100	
Junction Temperature	$T_J$	115	

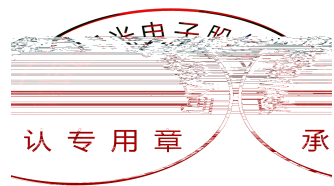

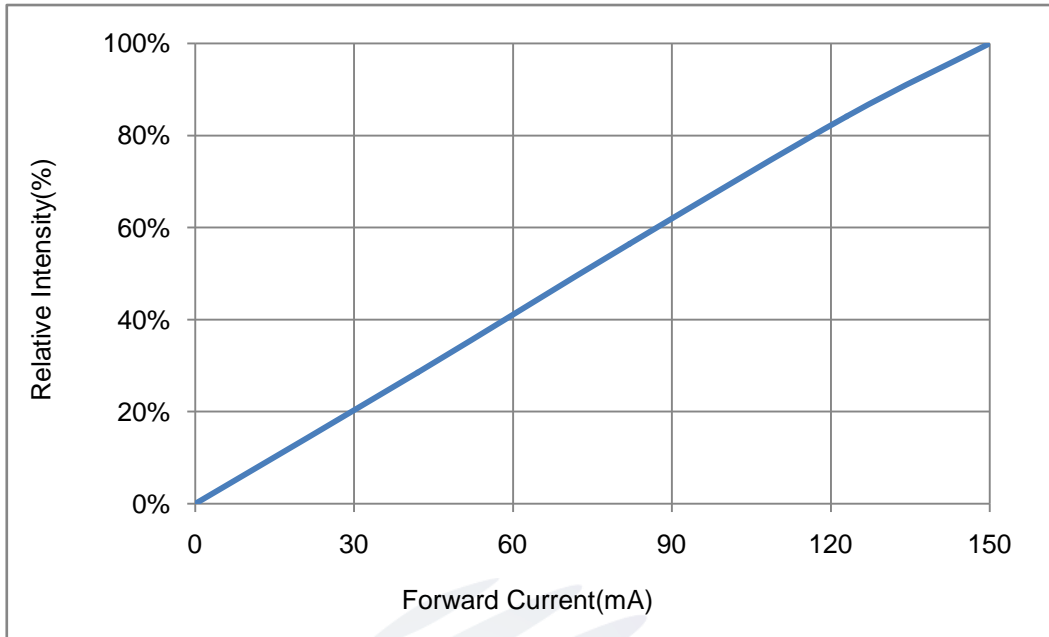

Fig.2- Forward Current Vs. Relative Power

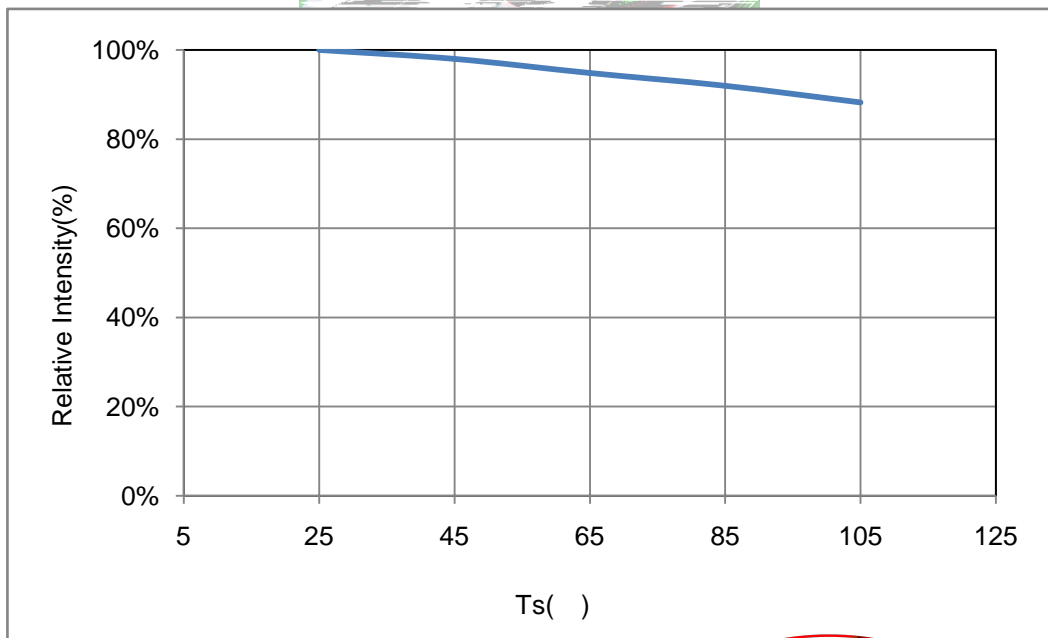
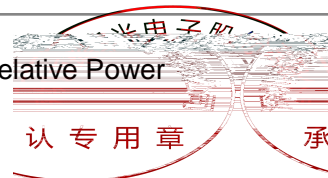

Fig.3-Solder Temperature VS. Relative Power



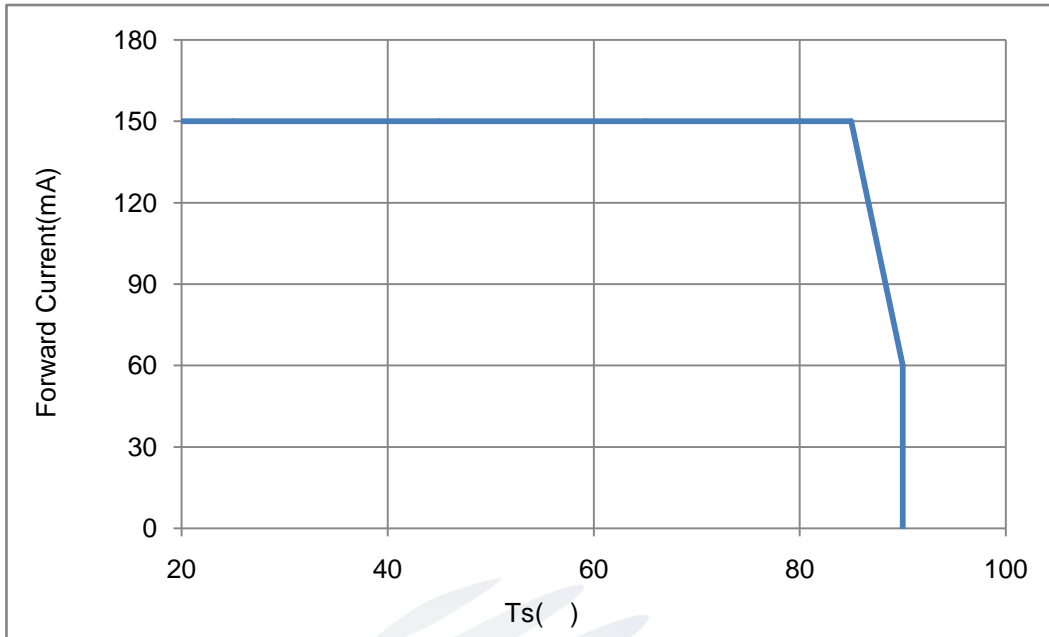

Fig.4-Ts Temperature VS. Forward Current

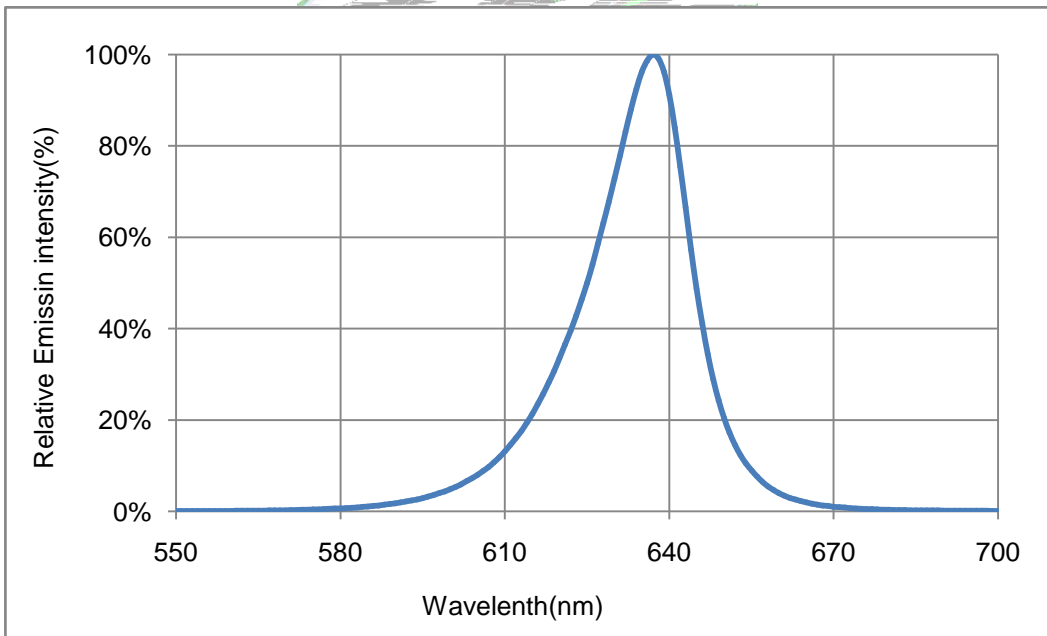
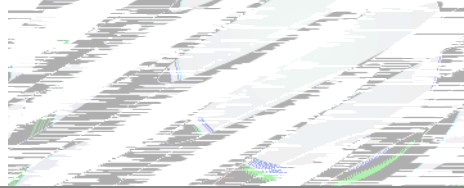
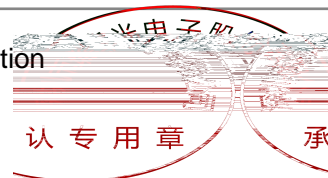

Fig.5-Spectrum Distribution





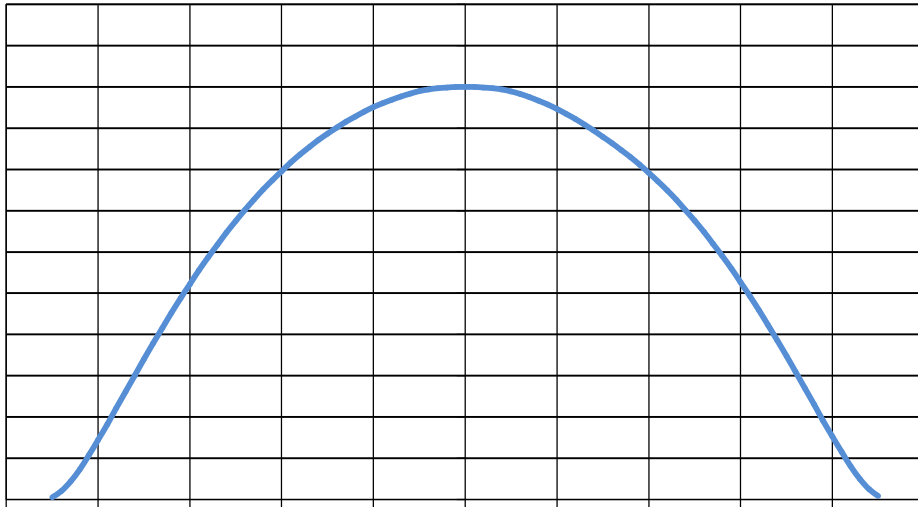
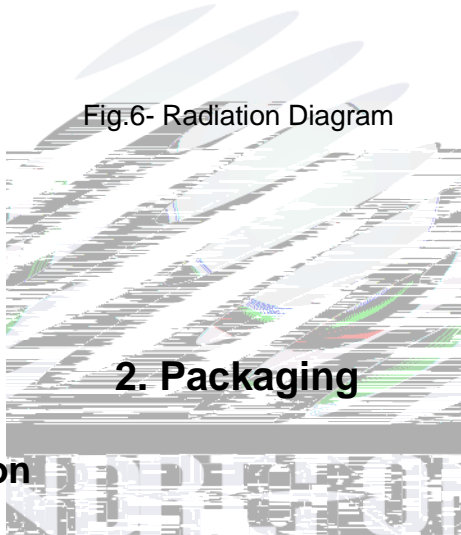

Fig.6- Radiation Diagram



**2. Packaging**

**2.1 Packaging Specification**

Package:4000pcs/reel.

**2.1.1 Carrier Tape Dimension**

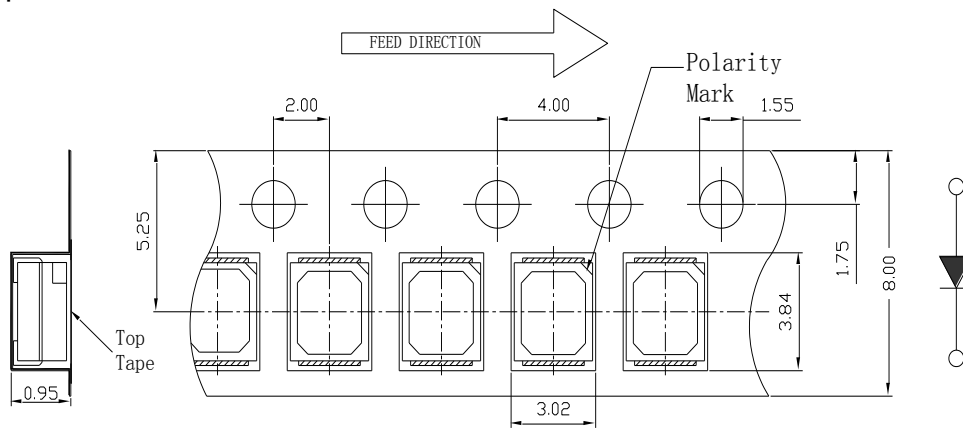

Fig.2-1 Carrier Tape Dimension

### 2.1.2 Reel Dimension

Table 2-1 Reel Dimension



A	12±0.1mm
B	178±1mm
C	60±1mm
D	13.0±0.5mm

Fig.2-2 Reel Dimension

#### Notes:

The tolerances unless mentioned ±0.1mm. Unit : mm .

### 2.1.3 Label Form Specification

Table 2-2 Label Form Specification

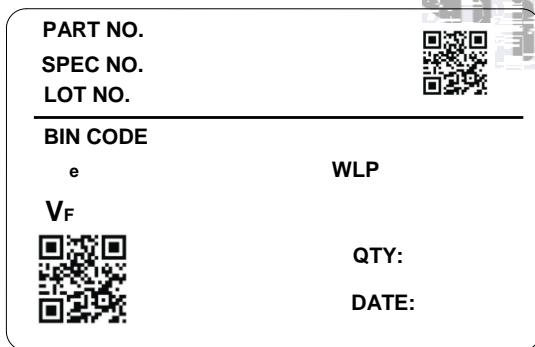

PART NO.	Part Number
SPEC NO.	Spec Number
LOT NO.	Lot Number
BIN CODE	Bin Code
Φe	Radiation flux
V <sub>F</sub>	Forward Voltage
WLP	Wavelength
QTY	Packing Quantity
DATE	Made Date

Fig. 2-3 Label Form Specification

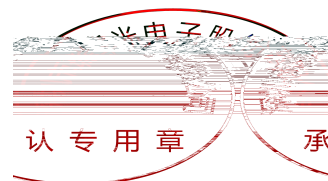

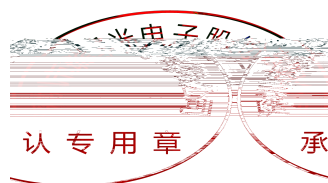

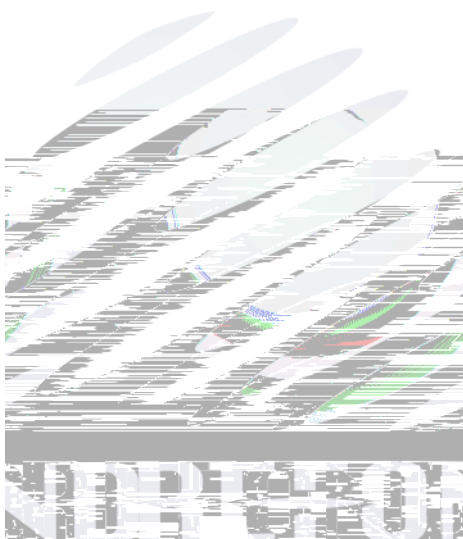

Notes:

1. U.S.L: Upper standard leve. L.S.L: Lower standard level.
2. The above reliability tests is based on the verification of a single/strip LED of Refond's existing experimental platform, the reliability experiment was taken under good heat dissipation conditions. when customers applies the LED to the series and parallel circuit, should take consideration of all the factors such as the current, voltage distribution, heat dissipation and others.
3. The technical information shown in the data sheets is limited to the typical characteristics and circuit examples of the referenced products. It does not constitute the warranting of industrial property nor the granting of any license.

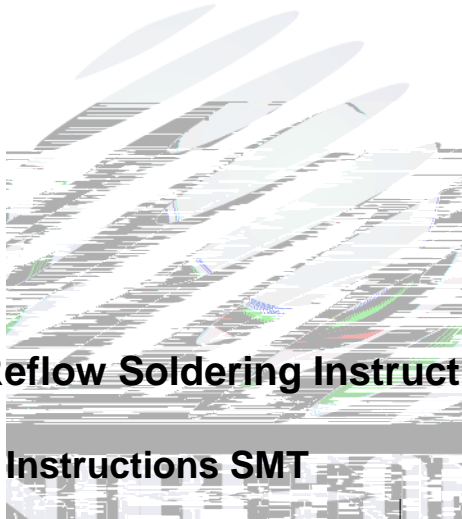

### 3. SMT Reflow Soldering Instructions SMT

#### 3.1 SMT Reflow Soldering Instructions SMT

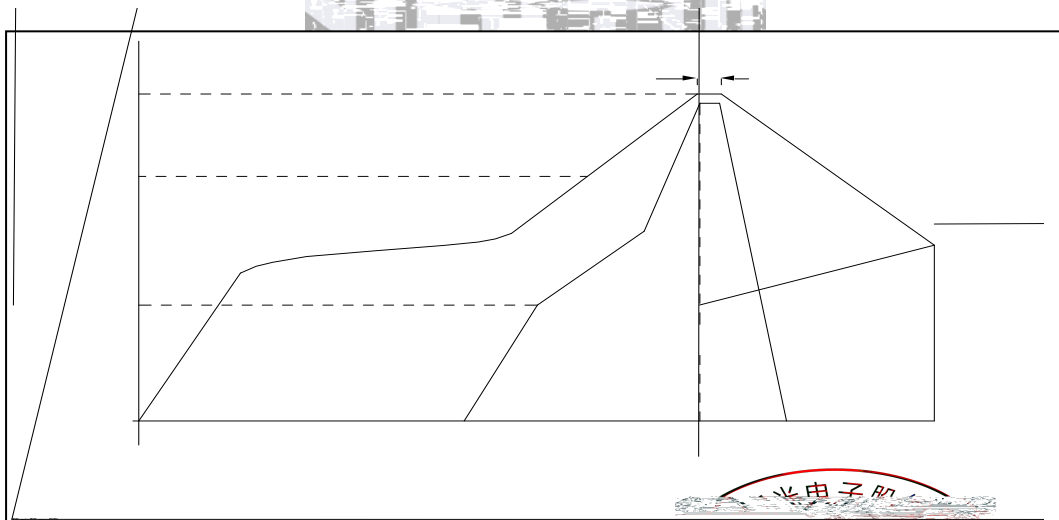

Fig.3-1 SMT Reflow Soldering Instructions SMT

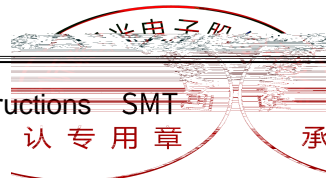

Table 3-1 SMT Reflow Soldering Instructions SMT

Average temperature rise speed (T <sub>max</sub> )	Max 3 °C/ s
Preheating: minimum temperature (T <sub>min</sub> )	150 °C
Preheating: Max temperature (T <sub>max</sub> )	200 °C
Preheating: Time (T <sub>min</sub> -T <sub>max</sub> )	60s-120s
Time limited to maintain high temperature: the temperature (T <sub>L</sub> )	217 °C
Time limited to maintain high temperature: The Time (t <sub>L</sub> )	Max 60s
Peak /Classification of temperature: (T <sub>P</sub> )	260 °C
Time limit classification of peak temperature time (t <sub>p</sub> )	Max 10s
Hold time within 5 °C with the actual peak temperature (TP)	Max 30s
Cooling speed	Max 6 °C/ s
Needed time from 25 °C to T <sub>p</sub>	Max 8 minutes

Notes:

- (1) Reflow soldering should not be done more than twice. If more than 24 hours between the two solderings , LED will be damaged.
- (2)When soldering , do not put stress on the LEDs during heating.

3.1.1 Soldering Iron

- (1) When do soldering by hand, keep the temperature of iron below less 300 less than 3 seconds.
- (2) Soldering by hand should be done only one time.

3.1.2 Repairing

Repairing should not be done after the LEDs have been soldered. When repairing is unavoidable, a double-head soldering iron should be used (as below figure). It should be confirmed in advance whether the characteristics of LEDs will or not be damaged by repairing.

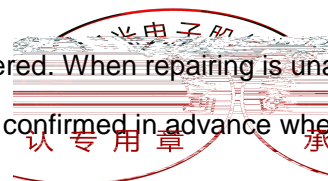



(4) Handle the component along the side surface by using forceps or appropriate tools; Do not directly touch or Handle the silicone lens surface, it may damage the internal circuitry.

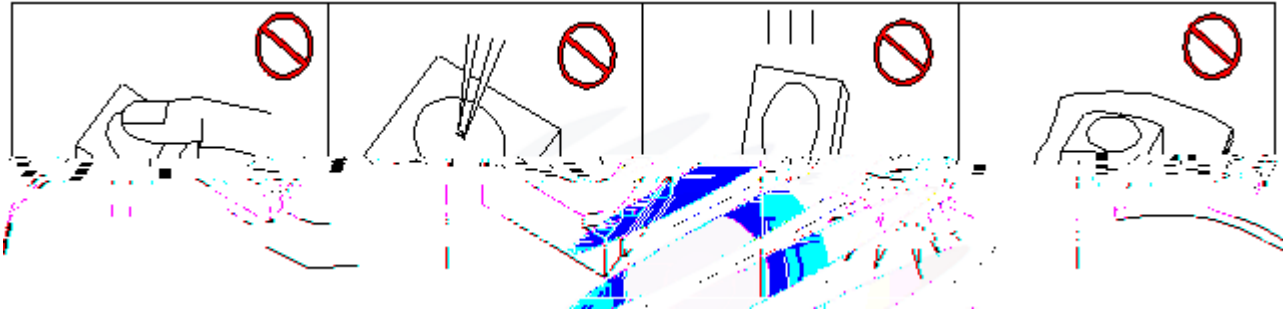

Fig 4-1 Operate Method

(5) In designing a circuit, the current through each LED can not exceed the absolute maximum rating specified for each LED. In the meanwhile, resistors for protection should be applied, otherwise slight voltage shift will cause big current change, burn out may happen. The driving circuit must be designed to allow forward voltage only when it is ON or OFF. If the reverse voltage is applied to LED, migration can be generated resulting in LED damage.

(6) Thermal Design is paramount importance because heat generation may result in the Characteristics decline, such as brightness decreased, Color change and so on. Please consider the heat generation of the LEDs when making the system design.

(7) Compared to standard encapsulants, silicone is generally softer, and the surface is more likely to attract dust, requiring special care during processing. In cases where a minimal level of dirt and dust particles cannot be guaranteed, a suitable cleaning solution must be applied to the surface after the soldering of components. Refond suggests using isopropyl alcohol for cleaning. In case other solvents are used, it must be assured that these solvents do not dissolve the package or resin. Ultrasonic cleaning is not recommended. Ultrasonic cleaning may cause damage to the LED.

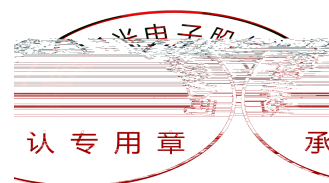



Table 4-1 Storage

Conditions		Temperature	Humidity	Time
Storage	Before Opening Aluminum Bag	≤30°C	≤75%	Within 1 Year From Date
	After Opening Aluminum Bag	≤30°C	≤60%	24hours
Baking		60±5°C	-	≥24hours

(8) If the moisture absorbent material silica gel has faded away or the LEDs have exceeded the storage time, baking treatment should be performed after unpacking and based on the following condition 65 5 for above 24 hours.

If the package is flatulence or damaged, please notify the sales staff to assist.

(9) Similar to most Solid state devices, LEDs are sensitive to Electro-Static Discharge (ESD) and Electrical Over Stress (EOS).

(10) Other points for attention, please refer to our relevant information.

