

# SPECIFICATION

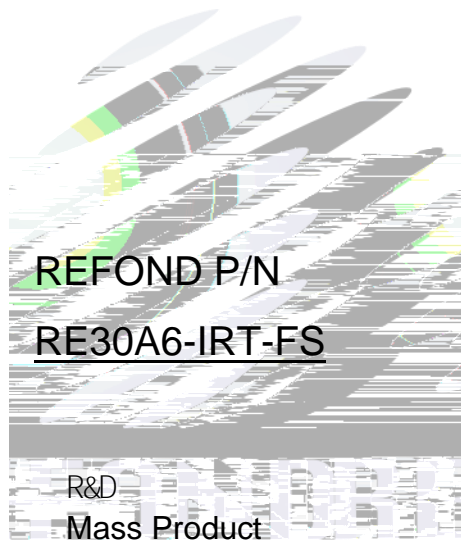

# Contents

1. Description	
1.1 General Description	
1.2 Features	
1.3 Application	
1.4 Package Dimension	
1.5 Product Parameters	
1.6 Typical optical characteristics curves	
2. Packaging	
2.1 Packaging Specification	
2.1.1 Carrier Tape Dimension	10
2.1.2 Reel Dimension	10
2.1.3 Label Form Specification	11
2.3 Cardboard Box	
2.4 Reliability Test Items And Conditions	
2.5 Criteria For Judging Damage	
3. SMT Reflow Soldering Instructions SMT	
3.1 SMT Reflow Soldering Instructions SMT	
4. Handling Precautions	
4.1 Handling Precautions	

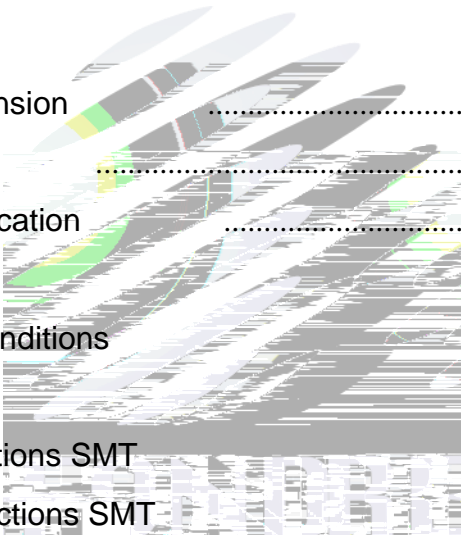

# 1. Description

## 1.1 General Description



This product uses the EMC package, it has a high reliability. it also be widely application for security monitoring and senso.

Size(mm): 3.00mmX3.00mmX2.53mm.

EMC

3.00mmX3.00mmX2.53mm

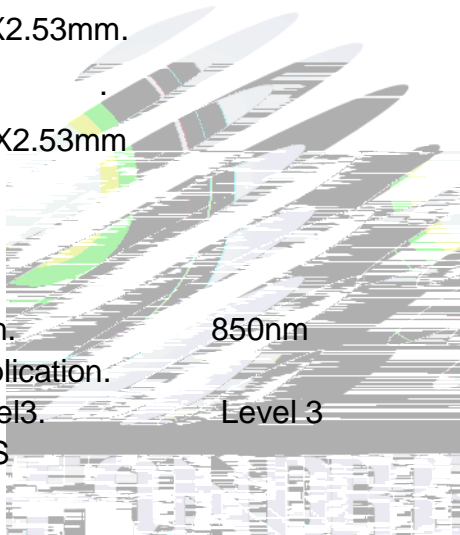

## 1.2 Features

Low forward voltage.

□ □ 850nm.

850nm

Pb-free reflow soldering application.

Moisture sensitive level:Level3.

Level 3

RoHS compliant. RoHS

## 1.3 Application

Surveillance systems.

Infrared Illumination for cameras.

Machine vision systems.



## 1.4 Package Dimension

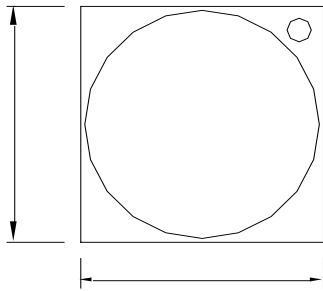

Fig.1-1 Top view



Fig.1-2 Polarity

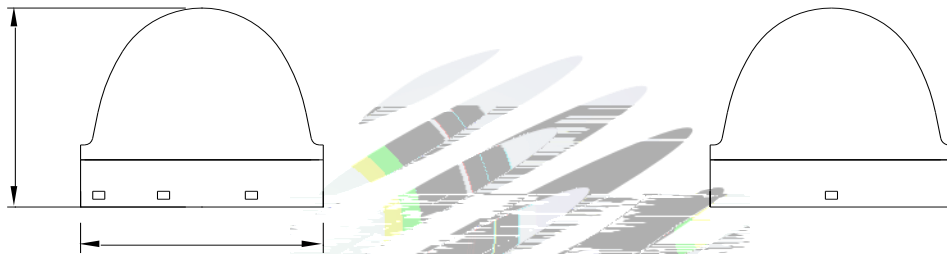

Fig.1-3 Side view

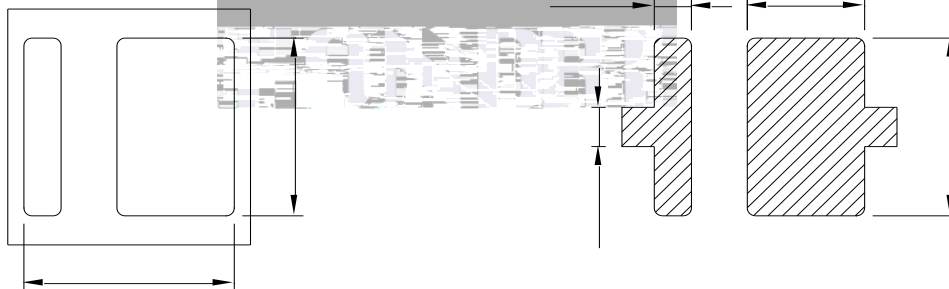

Fig.1-4 Bottom view

Fig.1-5 Soldering patterns

### Notes

1. All dimensions units are millimeters.
2. All dimensions tolerances are  $\pm 0.2\text{mm}$  unless otherwise noted.



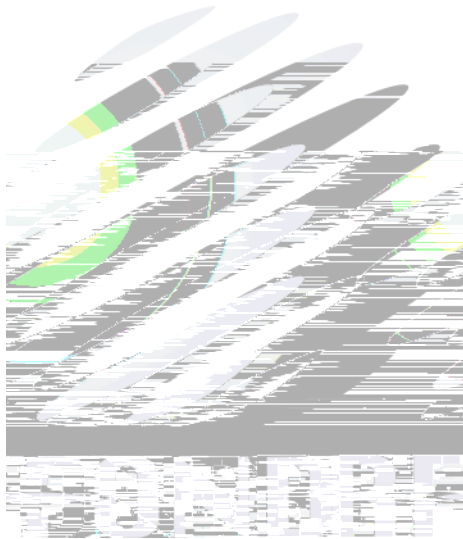

Table 1-2 Absolute Maximum Ratings at Ts=25°C

Parameter	Symbol	Rating	Units
Power Dissipation	$P_D$	0.9	W
Forward Current	$I_F$	500	mA
Reverse Voltage	$V_R$	5	V
Electrostatic Discharge (HBM)	$E_{SD}$	2000	V
Operating Temperature	$T_{OPR}$	-40 ~ +85	
Storage Temperature	$T_{OPR}$	-40 ~ +100	
Junction Temperature	$T_J$	115	

## Notes

1. 1/10 Duty cycle, 0.1ms pulse width.  $0.1ms, 1/10.$
2. The above forward voltage measurement allowance tolerance is  $\pm 0.1V.$   $\pm 0.1V.$
3. Tolerance of measurement of Total radiant flux/ Radiant Intensity:  $\pm 10%.$  /  $\pm 10%$
4. Care is to be taken that power dissipation does not exceed the absolute maximum rating of the product.

5. All measurements were made under the standardized environment of Refond.

6. When the LEDs are in operation the maximum current should be decided after measuring the package temperature, junction temperature should not exceed the maximum rate. LED

7. ESD yield is over 90% at 2000V ESD (HBM). ESD protection during products handling is needed. 90% LED  
 ESD2000V



## 1.6 Typical optical characteristics curves

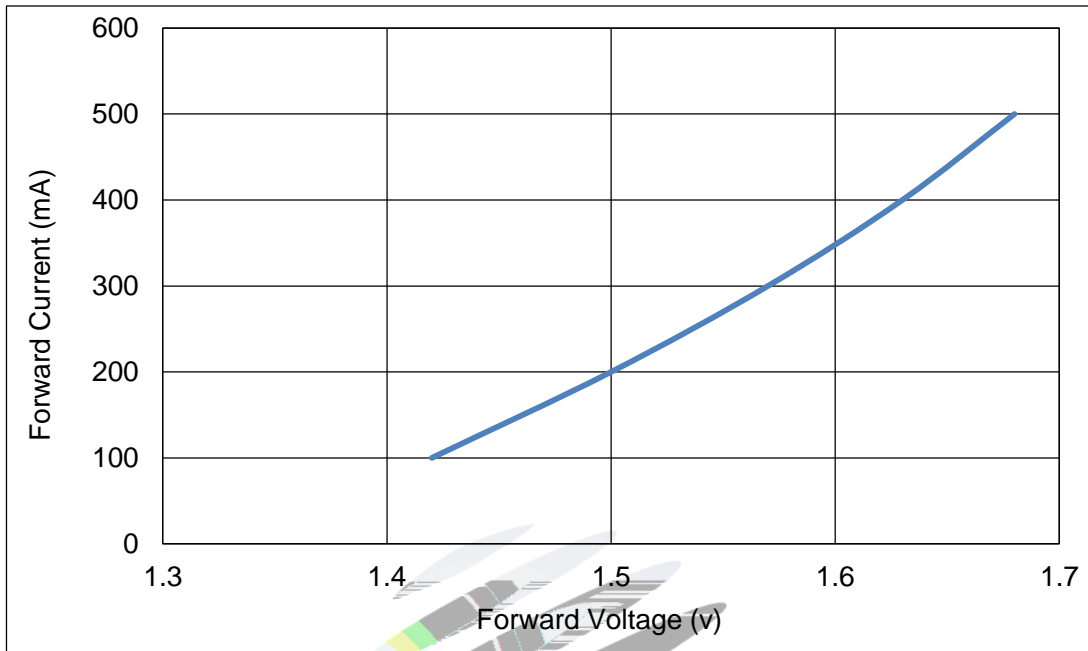

Fig 1-6 Forward Voltage Vs. Forward Current

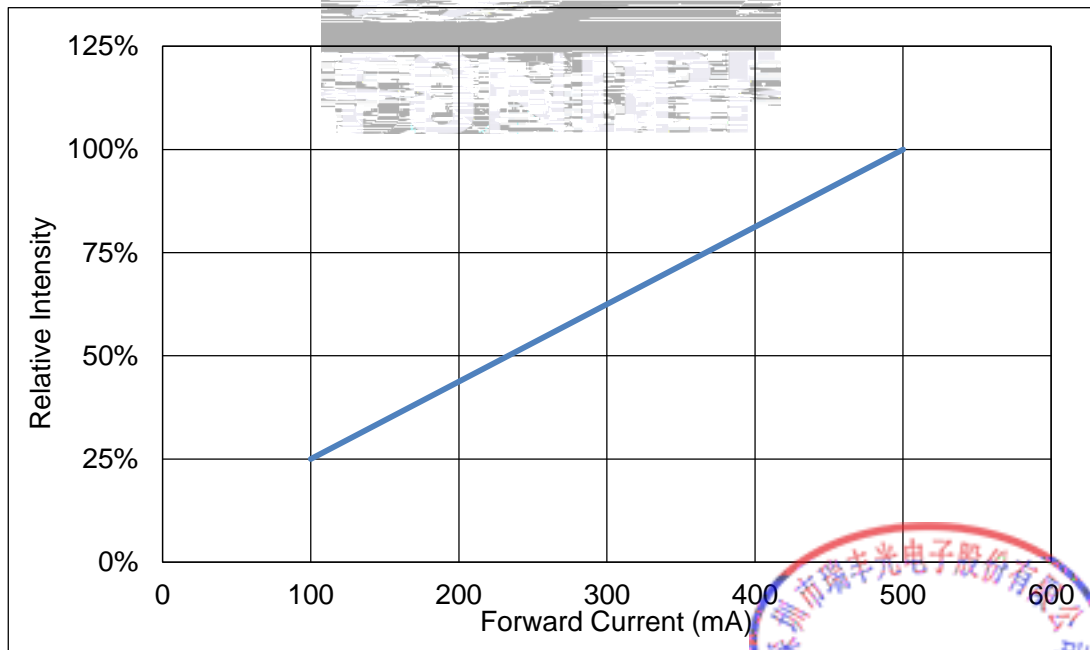
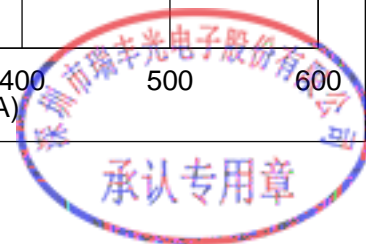

Fig 1-7 Forward Current Vs. Relative Intensity



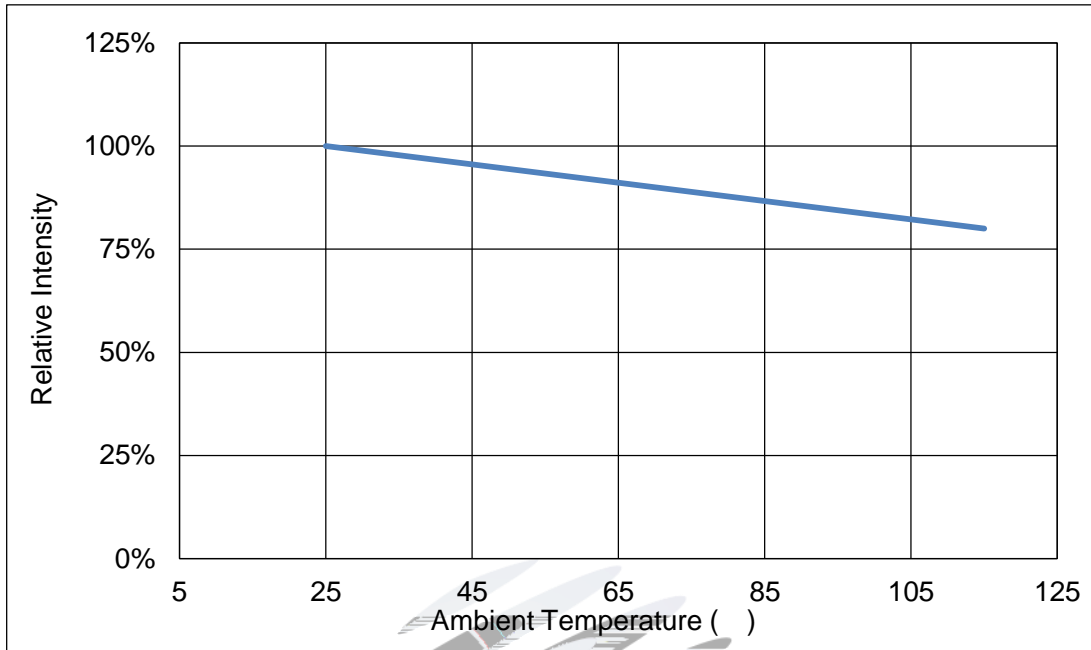

Fig 1-8 Ts Temperature Vs Relative Intensity

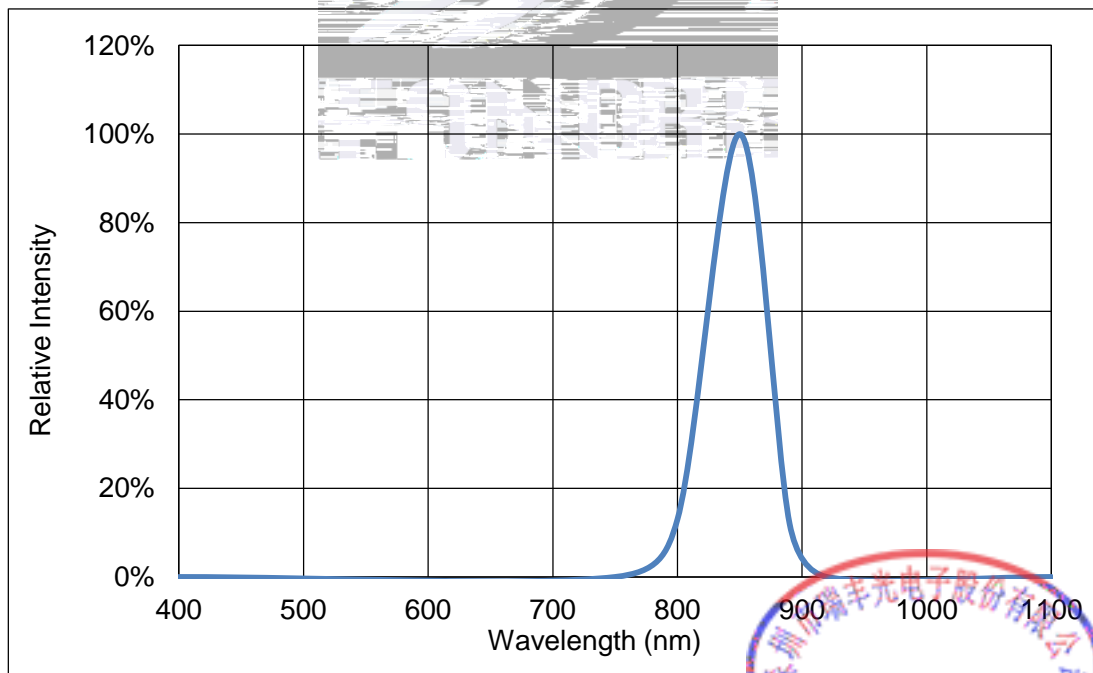
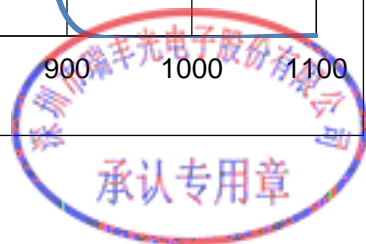

Fig 1-9 Spectrum Distribution





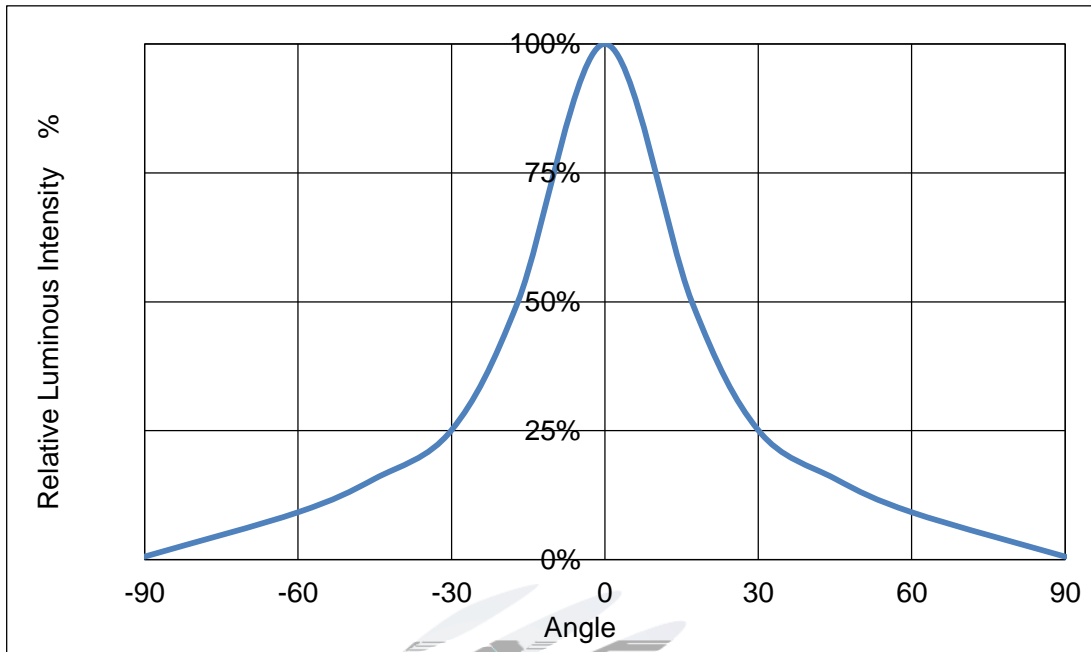

Fig 1-10 Radiation diagram

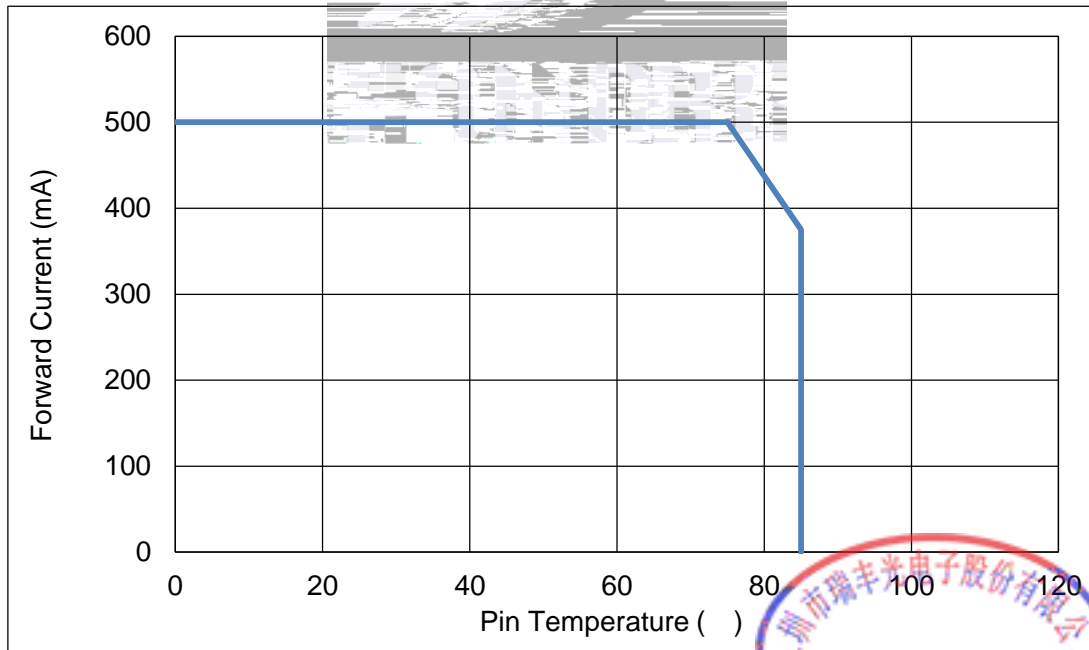
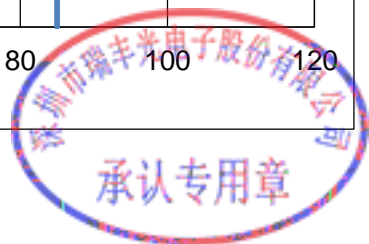

Fig 1-11 Ts Temperature Vs Forward Current



## 2. Packaging

### 2.1 Packaging Specification

Package:3000pcs/reel.                      3000pcs

#### 2.1.1 Carrier Tape Dimension

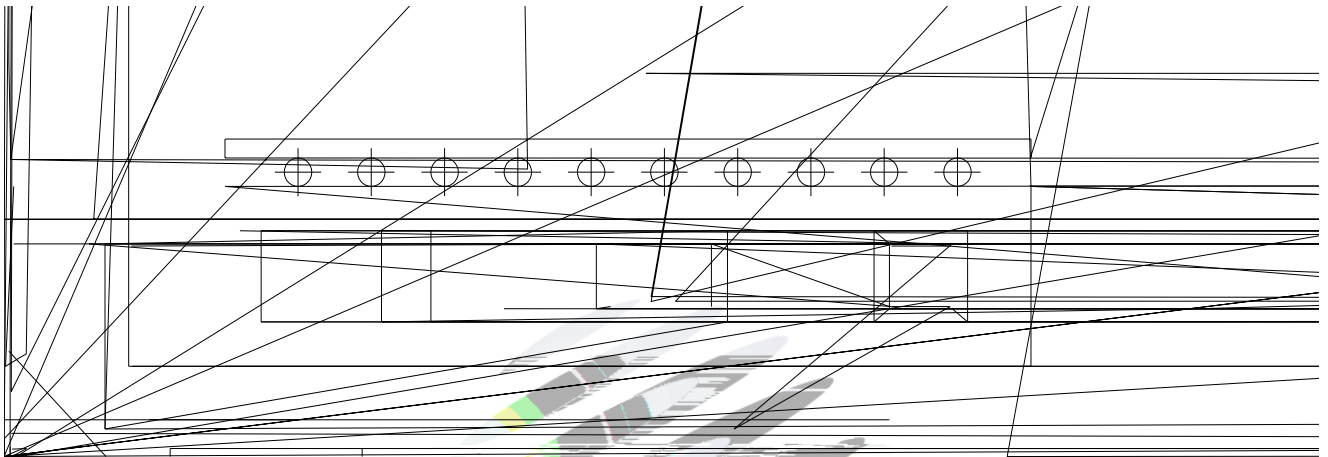

Fig.2-1 Carrier Tape Dimension

#### 2.1.2 Reel Dimension

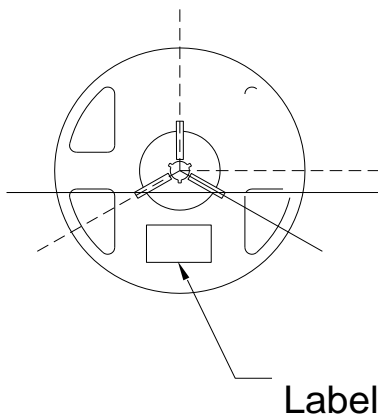

Fig.2-2 Reel Dimension

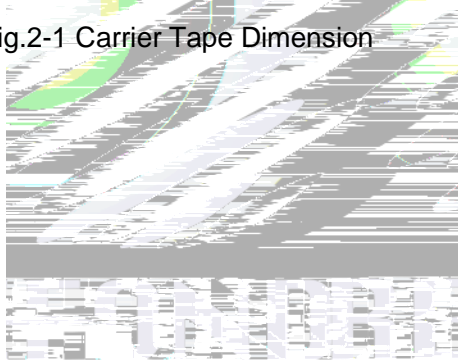

Table 2-1 Dimension

A	12.7±0.3mm
B	330.2±2mm
C	79.5±1mm
D	14.3±0.2mm

#### Notes

The tolerances unless mentioned ±0.1mm. Unit : mm 注：未注公差为±0.1毫米 尺寸单位：毫米



### 2.1.3 Label Form Specification

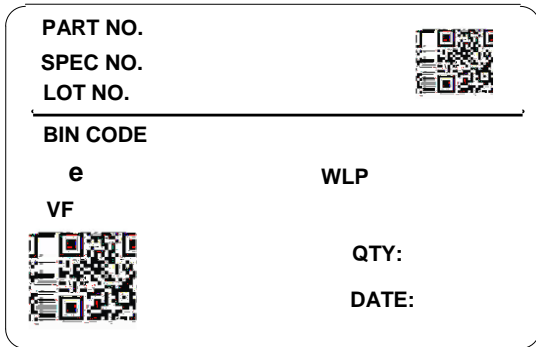

Fig 2-3 Label Form Specification

Table 2-2 Label Form Specification

PART NO	Part Number
SPEC NO	Spec Number
LOT NO	Lot Number
BIN CODE	Bin Code
	Total radiant flu
WLP	Peak Wavelength
VF	Forward Voltage
QTY	Packing Quantity
DATE	Made Date

### 2.2 Moisture Resistant Packing

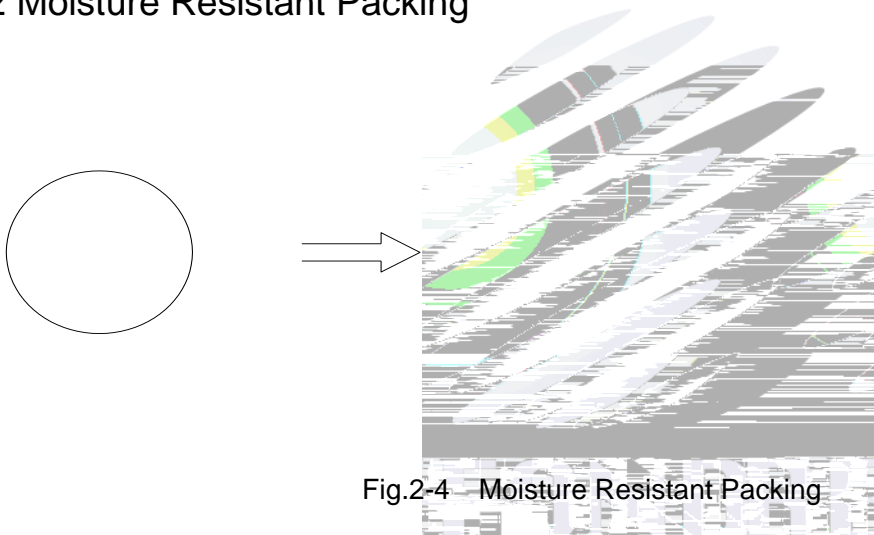

Fig.2-4 Moisture Resistant Packing

### 2.3 Cardboard Box

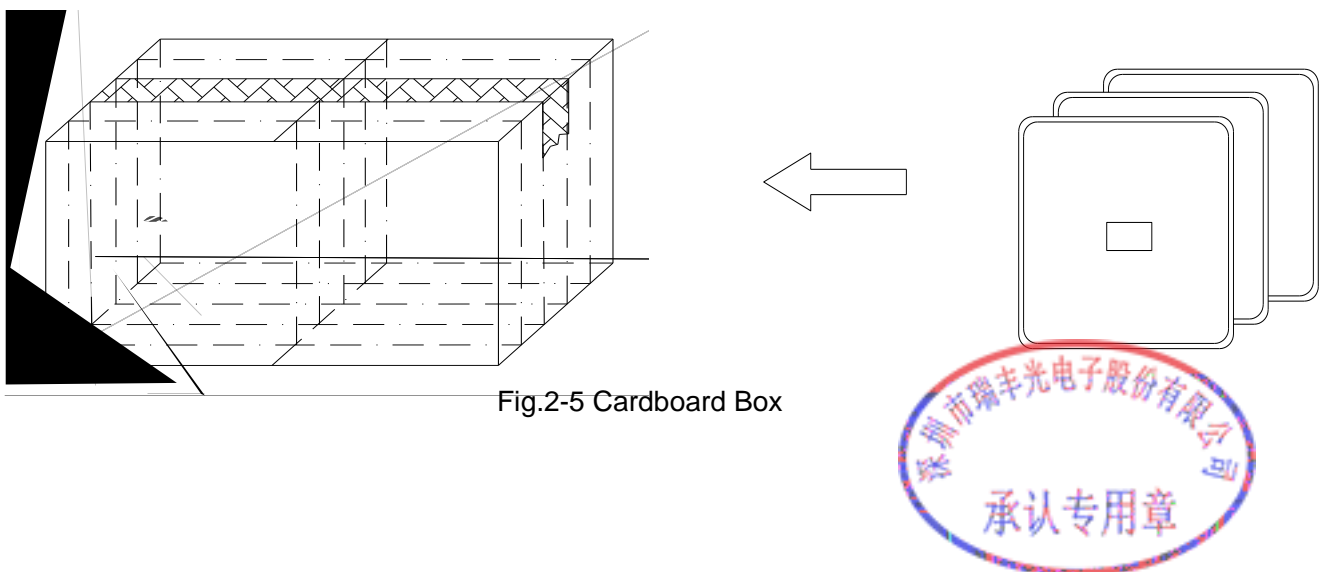

Fig.2-5 Cardboard Box



## 2.5 Criteria For Judging Damage

Table Criteria For Judging Damage

Test Items	Symbol	Test Condition	Criteria For Judgement	
			Min.	Max.
Forward Voltage	$V_F$	$I_F=500mA$	-	U.S.L*)x1.1
Reverse Current	$I_R$	$V_R = 5V$	-	U.S.L*)x2.0
Total radiant flux	$e$	$I_F=500mA$	L.S.L*)x0.7	-

### Notes

1.U.S.L: Upper standard level

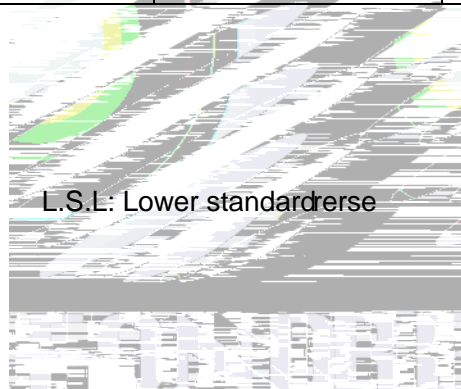

### 3. SMT Reflow Soldering Instructions SMT

#### 3.1 SMT Reflow Soldering Instructions SMT

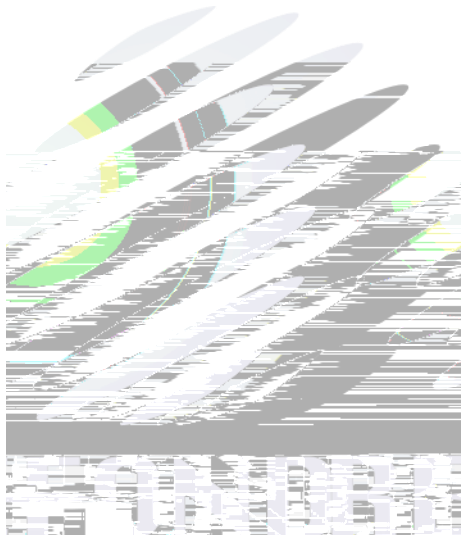

(1) Reflow soldering should not be done more than two times. In the case of more than 24 hours passed soldering after first, LEDs will be damaged.

24

LED

(2) When soldering , do not put stress on the LEDs during heating.

### 3.1.1 Soldering Iron

(1) When hand soldering, keep the temperature of iron below less 300°C less than 3 seconds

300

3

The hand solder should be done only one time.

### 3.1.2 Repairing

Repair should not be done after the LEDs have been soldered. When repairing is unavoidable,a double-head soldering iron should be used (as below figure). It should be confirmed in advance whether the characteristics of LEDs will o

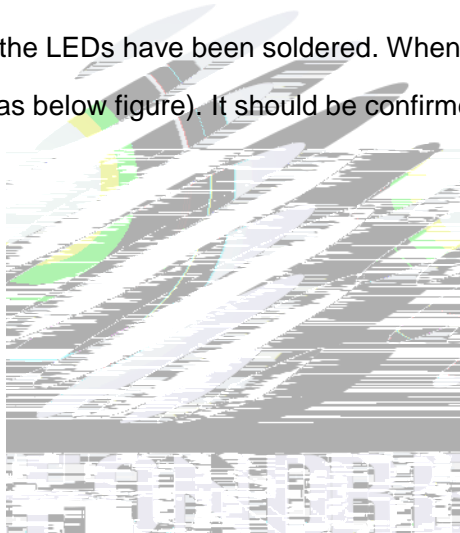

## 4. Handling Precautions

### 4.1 Handling Precautions

(1) LED operating environment and sulfur element composition cannot be over 100PPM in the LED mating usage material. This is provided for informational purposes only and is not a warranty or endorsement.

LED

100PPM.

(2) In order to prevent external material from getting into the inside of LED, which may cause the malfunction of LED, the single content of Bromine element is required to be less than 900PPM, the single content of Chlorine element is required to be less than 900PPM, the total content of Bromine element and Chlorine element in the external materials of the application products is required to be less than 1500PPM. This is provided for informational purposes only and is not a warranty or endorsement.

LED

900PPM

900PPM

1500PPM.

(3) VOCs (Volatile organic compounds) emitted from materials used in the construction of fixtures can penetrate silicone encapsulants of LEDs and discolor when exposed to heat and photonic energy. The result can be a significant loss of light output from the fixture. Knowledge of the properties of the materials selected to be used in the construction of fixtures can help prevent these issues. Refond advises against the

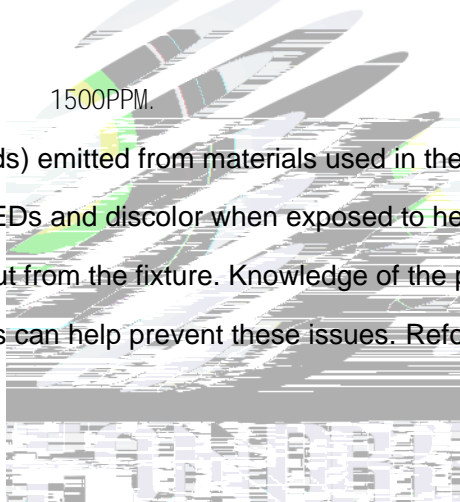



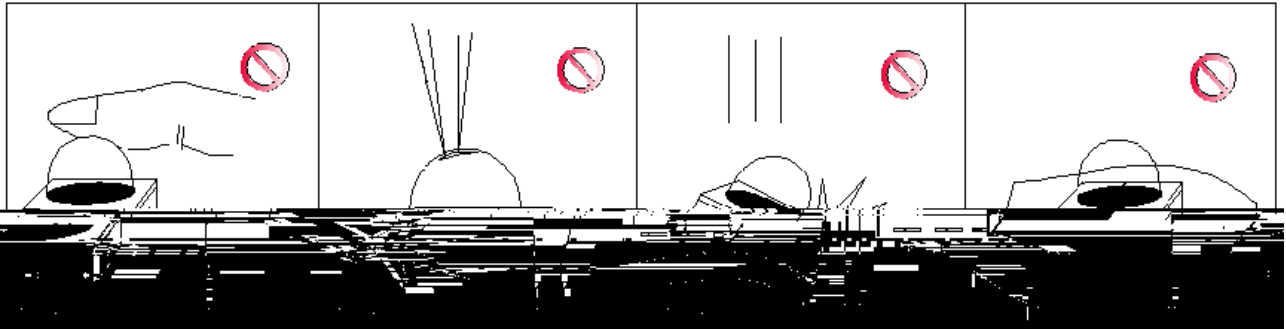
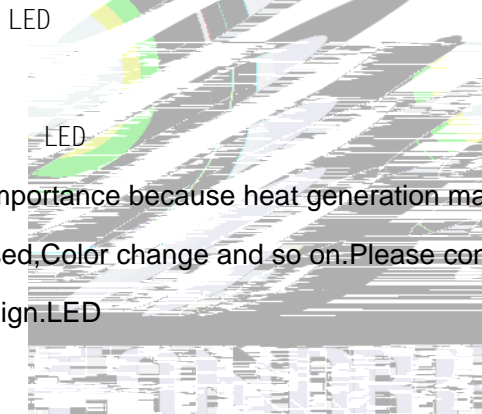

Fig 4-1

(5) In designing a circuit, the current through each LED can not be exceed the absolute maximum rating specified for each LED. In the meanwhile, resistors for protection should be applied, otherwise slight voltage shift will cause big current change, burn out may happen. The driving circuit must be designed to allow forward voltage only when it is ON or OFF. If the reverse voltage is applied to LED, migration can be generated resulting in LED damage.



(6) Thermal Design is paramount importance because heat generation may result in the Characteristics decline, such as brightness decreased, Color change and so on. Please consider the heat generation of the LEDs when making the system design.

(7) Compared to standard encapsulants, silicone is generally softer, and the surface is more likely to attract dust, requiring special care during processing. In cases where a minimal level of dirt and dust particles cannot be guaranteed, a suitable cleaning solution must be applied to the surface after the soldering of components. Refond suggests using isopropyl alcohol for cleaning. In case other solvents are used, it must be assured that these solvents do not dissolve the package or resin. Ultrasonic cleaning is not recommended. Ultrasonic cleaning may cause damage to the LED.



Table 4-1 Storage

Conditions		Temperature	Humidity	Time
Storage	Before Opening Aluminum Bag	30	75%	Within 1 Year From Date
	After Opening Aluminum Bag	30	60%	168hours 168
Baking		60± 5	-	24hours 24

(8) If the moisture absorbent material (silica gel) has faded away or the LEDs have exceeded the storage time , baking treatment should be performed after unpacking and based on the following condition (60±5) °C for above 24 hours.

60

± 5          24

If the package is flatulence or damaged, please notify the sales staff to assist.

(9) Similar to most Solid state devices; LEDs are sensitive to Electro-Static Discharge (ESD) and Electrical Over Stress (EOS).

LED

(10) Other points for attention, please refer to our relevant information.







Declare

This specification is written both in English and in Chinese and the latter is formal.

